



a
thing of
beauty.
a joy
forever.

Kajaria
ETERNITY
tiles forever

THE ULTIMA
1200X2400 MM CATALOGUE

INDIA'S NO. **1** TILE COMPANY
IS ALSO WORLD'S

8TH LARGEST MANUFACTURER
OF TILES

The Ultima



CONTINUA+

ULTIMA: NOW WITH CONTINUA+ TECHNOLOGY

- Fully automatic pressing technology for the production of large slabs
- Superior surface flatness when compared to conventional pressing
 - Consistent and homogenous density
- Greater body strength and flexibility due to uniform roller pressing
 - Unequaled shine, perfect slab planarity

Introduction 1200x2400 mm

Beauty as big as your vision. Expansive and elegant, the Ultima tiles create a sense of grandeur and space that you can only get from the extra-large premium tile. With a variety of stunning finishes and nature inspired designs, it's the perfect way to create grand urban spaces with limitless beauty.

Finishes

Inspired by the beauty of nature, 1200x2400 mm Ultima tiles offer the perfect fit for every aesthetic design choice to be elevated to the next level. Available in seven elegant finishes that bring out classic patterns, they're perfect to add style and sophistication to any space.



SUPERWHITE

With an 'L' value of more than 94, these striking white tiles promise the whitest finish available in India.

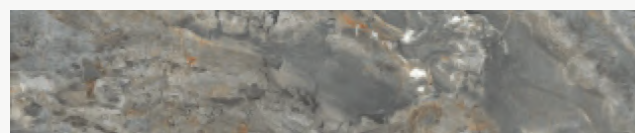

PREMIUM POLISH

Premium Polish – The most premium transparent glaze that ensures a graphic and unparalleled sharpness, giving it a high definition retina image.



POLISH

The high-shine tiles of India, these have a Reflective Index Value of more than 103%. You can almost use it as a mirror.



MARBLETECH

Marbletech – The elegant look and feel of real marble in terms of touch, feel and shine makes it difficult to distinguish between the Ultima slabs and real marble.



BEYOND

A luxury series in tile design, with the most premium surface. These tiles are developed with advanced digital technology. Almost Zero Surface Reflection, with wider possibilities of tonalities and intensity, and the finest Integration of designs and elegance.



BLEND

Inspired by nature, these tiles are closest to natural marbles/stones. These are made and designed using rare minerals and metal in their veins and drafted with precision, to impart real depth/ shine, to enhance overall surface and design of the tile, adding a realistic touch and ambience of nature to your home.



MATT

Matt – With a sophisticated matt finish and high durability, these tiles can withstand heavy footfall and yet, they're easily maintained.

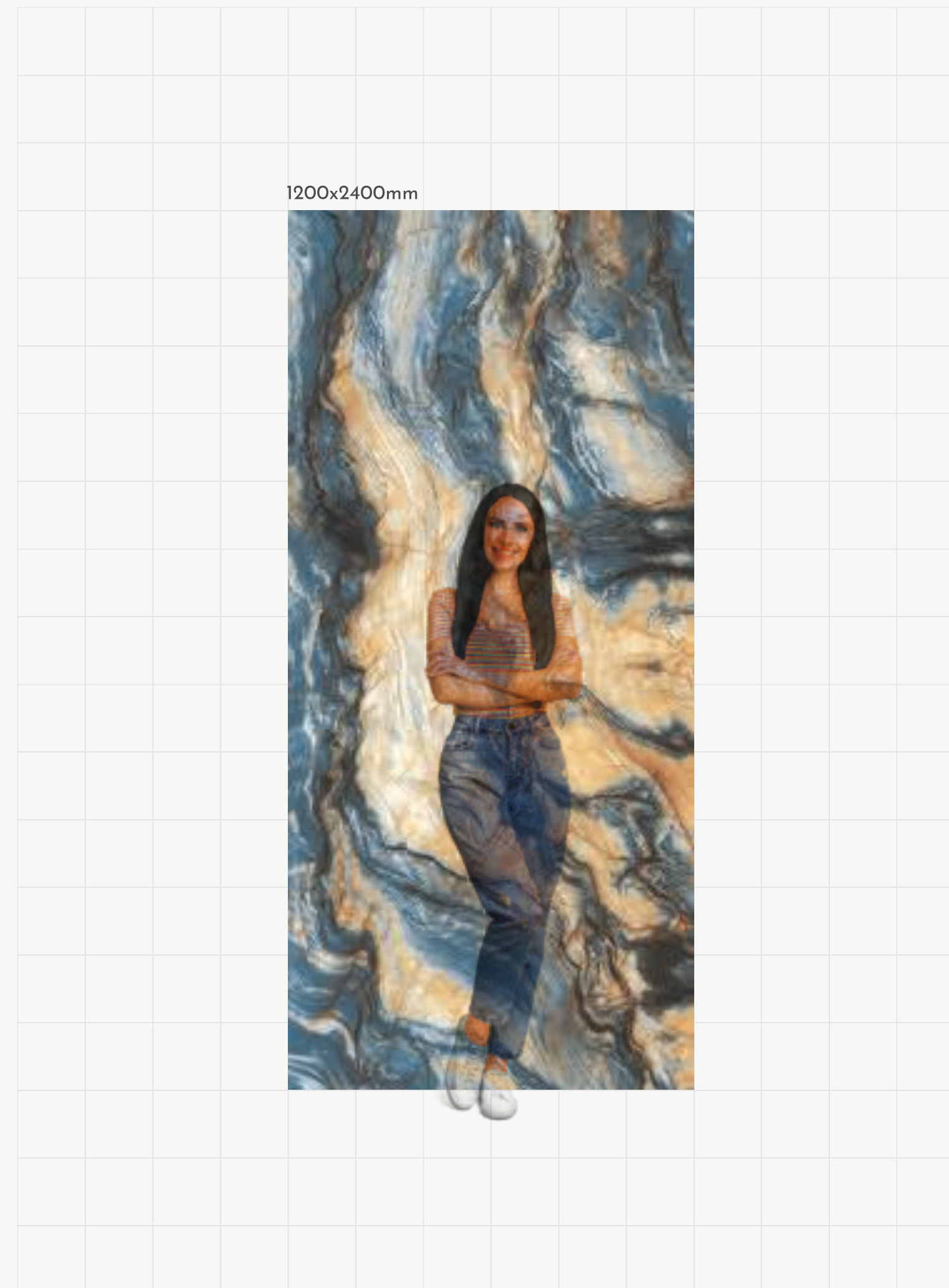

Beautifully Elegant.
Technically Superior.

Features



Scratch Resistant



Stain Resistant



Fire Resistant



High Abrasion Resistant



Easy Installation



Chemical Resistant



0 % Water Absorption



9mm Thickness



Thermal Resistant



Zero Maintenance



Easy To Clean



High Flexural Strength

Adding a sense of elegance to every space, without any compromise on durability and usability is at the heart of Ultima. Choose from stunning designs to lend a stunning aura to any usage area, with the assurance of knowing that it'll last for years to come.

THE ULTIMA
1200x2400 mm



- For wall application
- For floor application
- Fine detailing
- Stain resistant

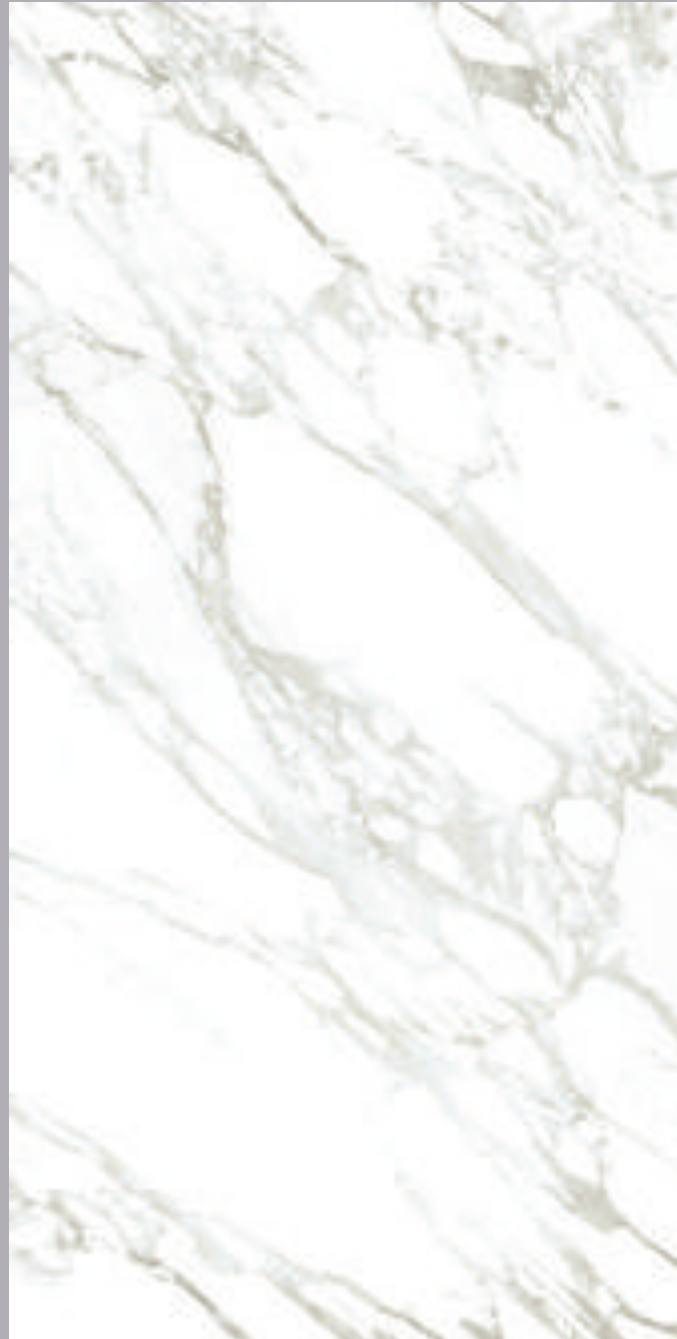

BOOK MATCH

CARRARA LUXE



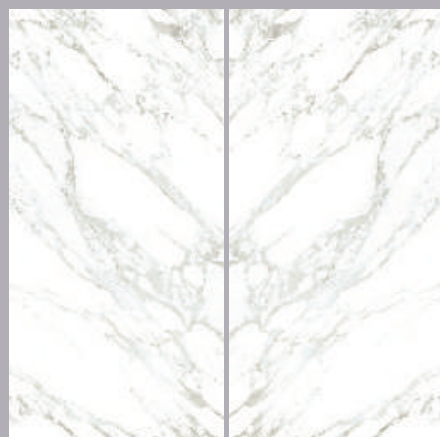

SUPERWHITE



RANDOM - 2
THICKNESS - 9 MM



THE ULTIMA
1200x2400 mm

-  For wall application
-  For floor application
-  Fine detailing
-  Stain resistant



Click Here

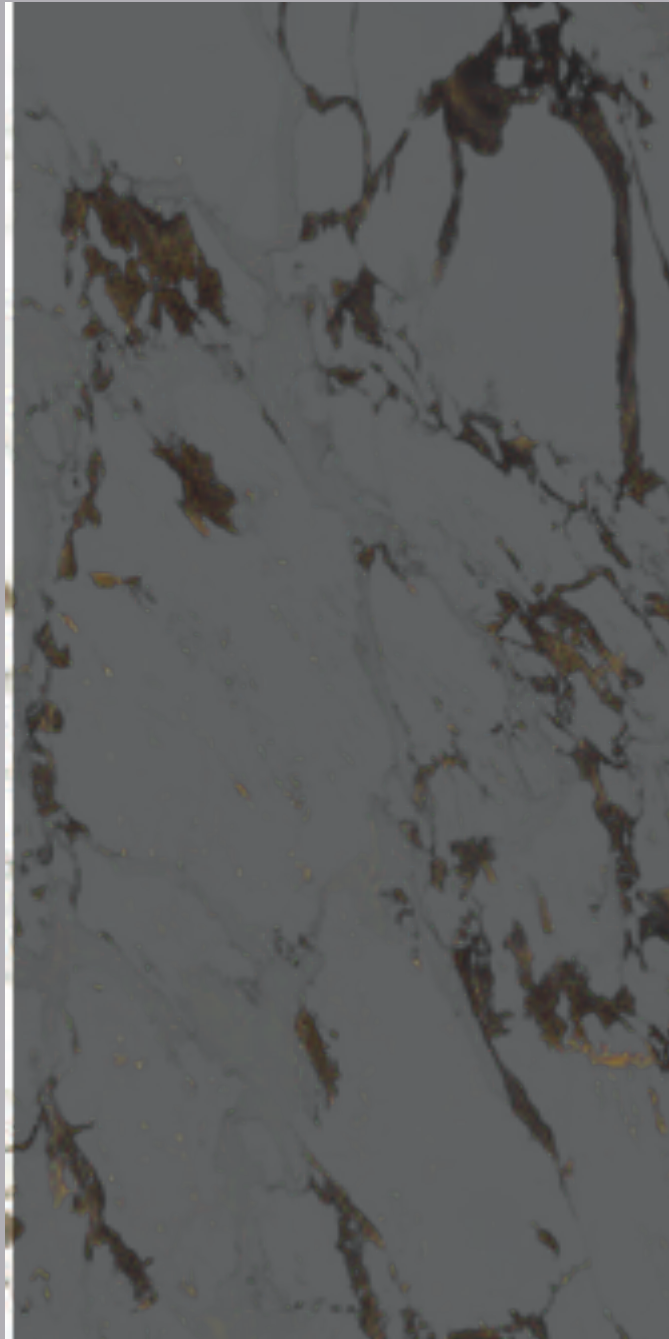

ARBESCATO LUXE



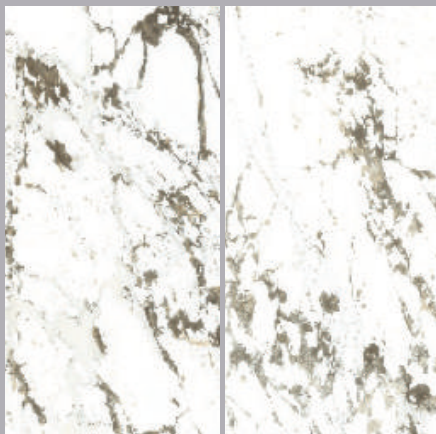

SUPERWHITE



RANDOM - 2
THICKNESS - 9 MM



THE ULTIMA
1200x2400 mm

-  For wall application
-  For floor application
-  Fine detailing
-  Stain resistant

360°
Click Here

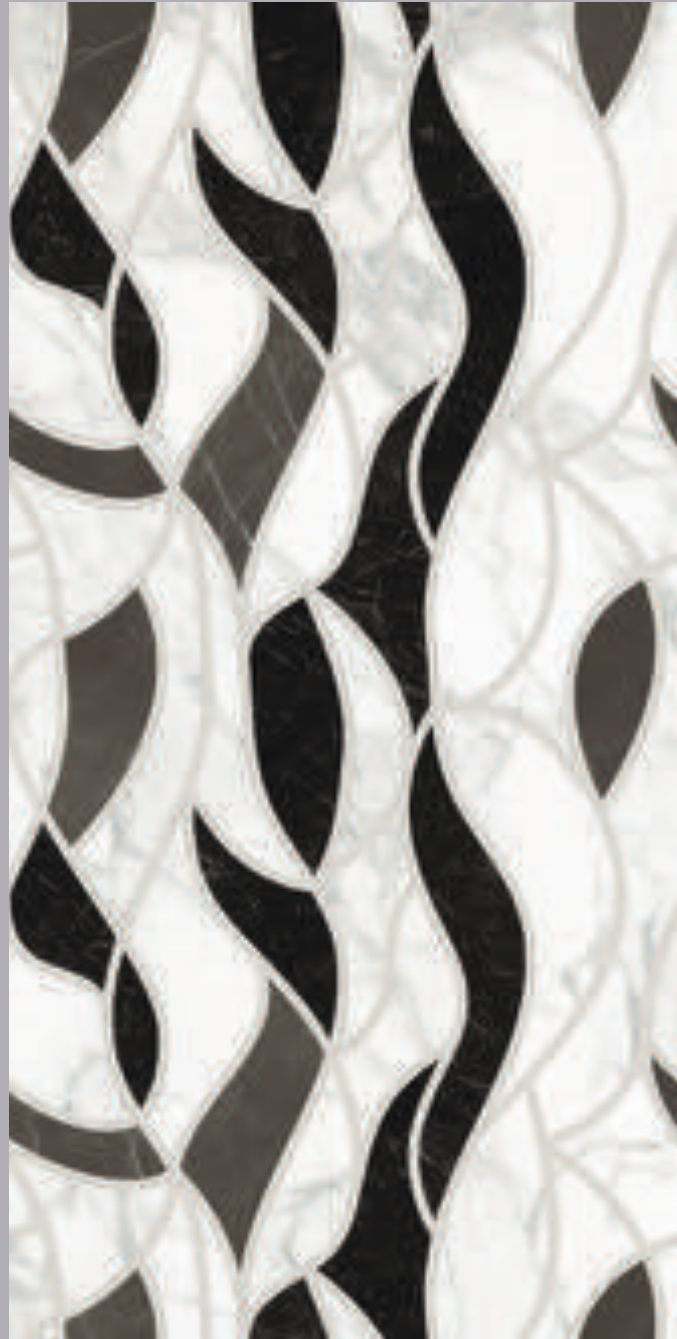

MARBELO DECOR

SUPERWHITE

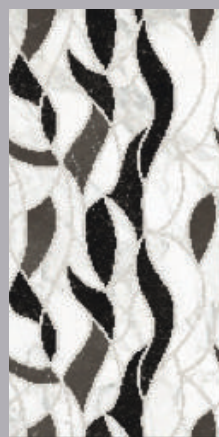

RANDOM - 1
THICKNESS - 9 MM



MARBELO DECOR & BOTTOCINO | SUPERWHITE & BLEND

THE ULTIMA
1200x2400 mm

-  For wall application
-  For floor application
-  Fine detailing
-  Stain resistant



Click Here



CONTINUOUS GRAPHIC

SATUARIO

SUPERWHITE

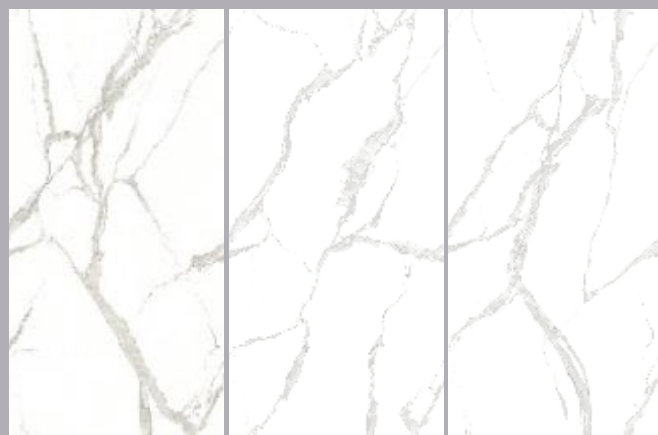

RANDOM - 3
THICKNESS - 9 MM



THE ULTIMA
1200x2400 mm



- For wall application
- For floor application
- Fine detailing
- Stain resistant

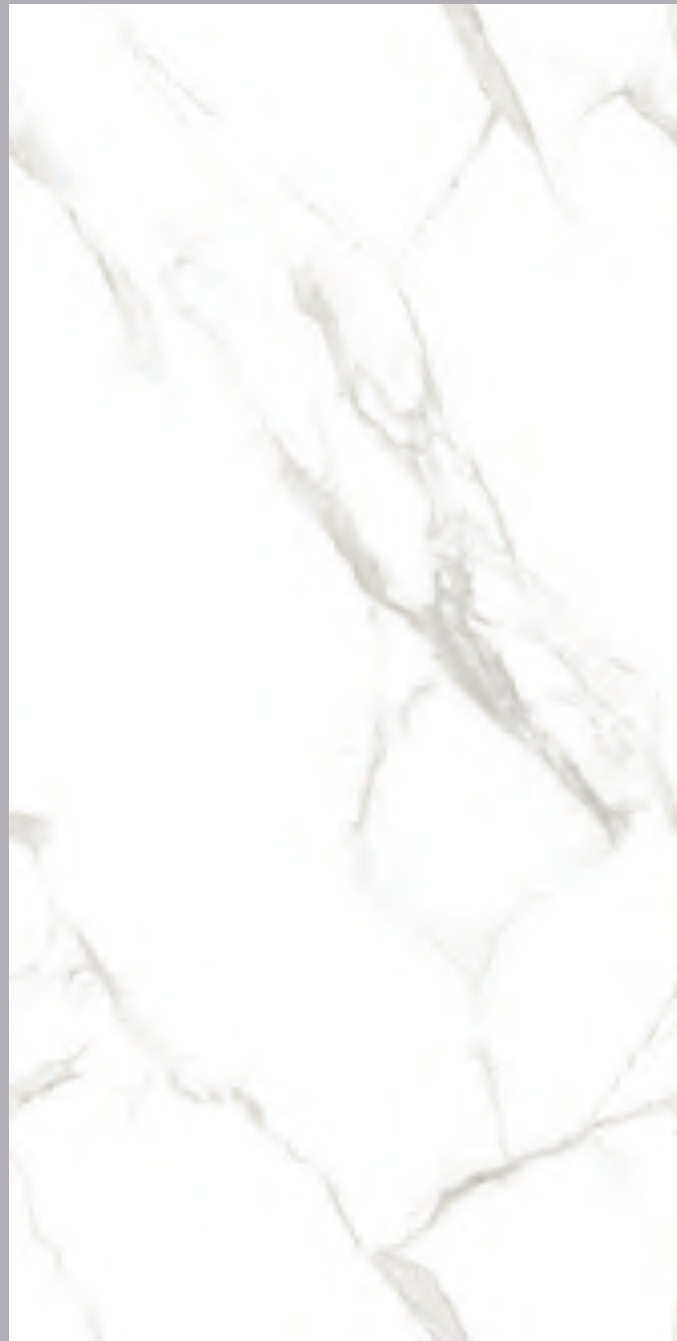

CONTINUOUS GRAPHIC

SATUARIO LUXE

SUPERWHITE

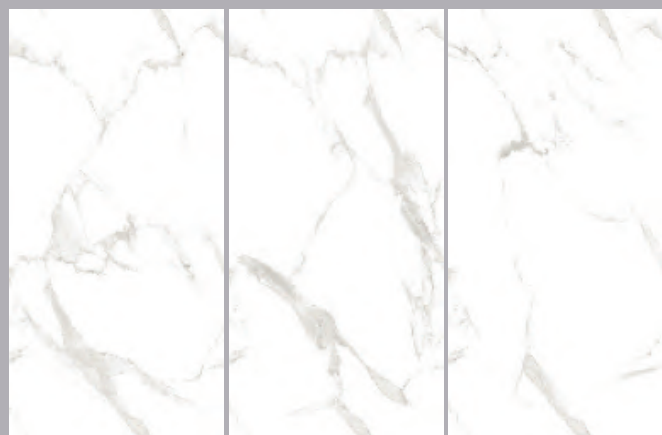

RANDOM - 4
THICKNESS - 9 MM



SATUARIO LUXE (CONTINUOUS GRAPHIC) | SUPERWHITE

THE ULTIMA
1200x2400 mm

360°
Click Here

-  For wall application
-  For floor application
-  Fine detailing
-  Stain resistant



ONYX BEIGE

SUPERWHITE



RANDOM - 2
THICKNESS - 9 MM



ONYX BEIGE | SUPERWHITE

THE ULTIMA
1200x2400 mm

360°
Click Here

- For wall application
- For floor application
- Fine detailing
- Stain resistant



ONYX BEIGE DECOR

SUPERWHITE



RANDOM - 2
THICKNESS - 9 MM



THE ULTIMA
1200x2400 mm

360°
Click Here

- For wall application
- For floor application
- Fine detailing
- Stain resistant



APOLLO GREY

PREMIUM POLISH



RANDOM - 2
THICKNESS - 9 MM



APOLLO GREY | PREMIUM POLISH

THE ULTIMA
1200x2400 mm



- For wall application
- For floor application
- Fine detailing
- Stain resistant

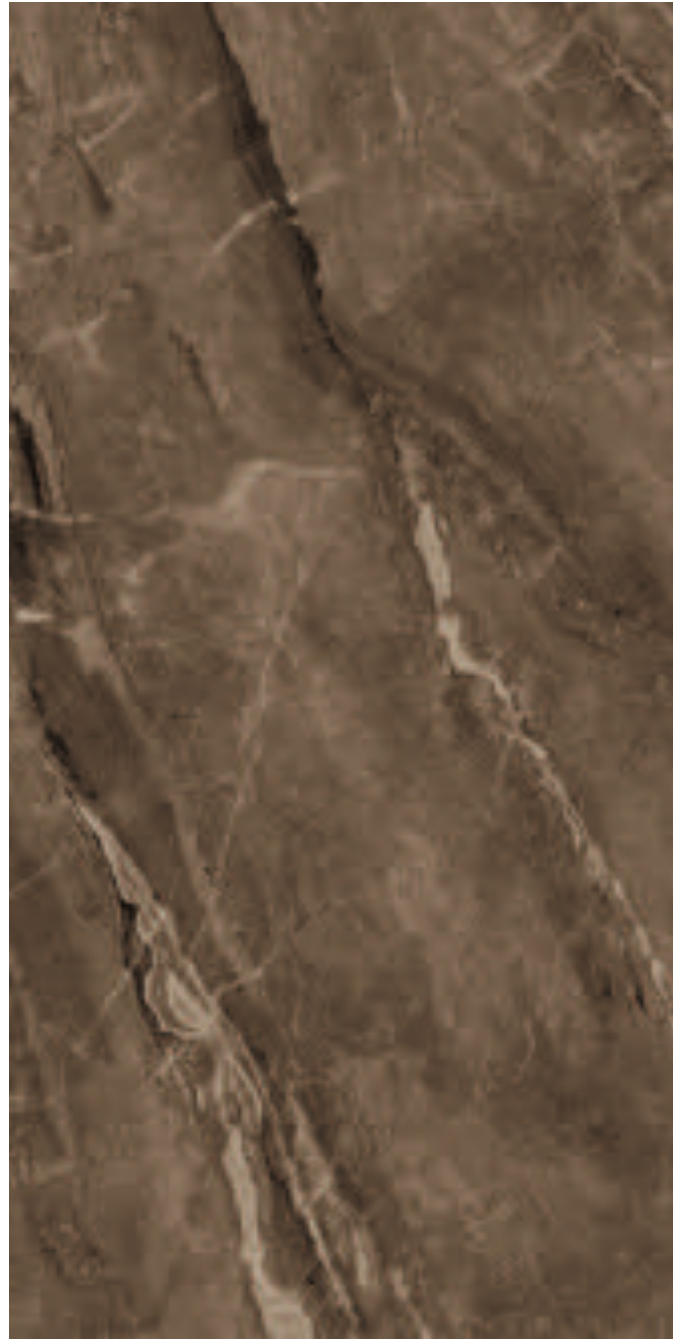

ASTONIA BRONZE PREMIUM POLISH

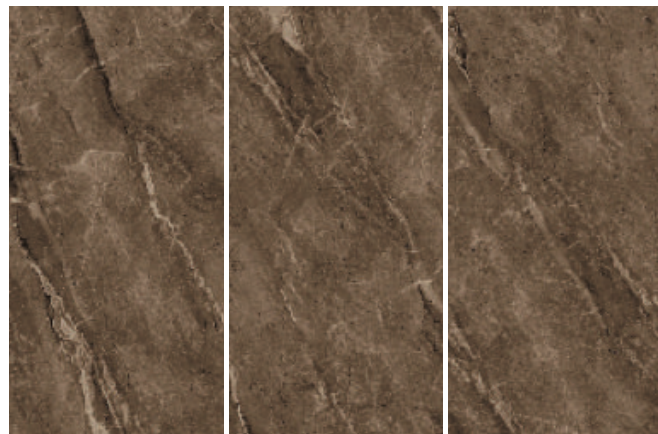

RANDOM - 3
THICKNESS - 9 MM



ASTONIA BRONZE | PREMIUM POLISH

THE ULTIMA
1200x2400 mm



- For wall application
- For floor application
- Fine detailing
- Stain resistant

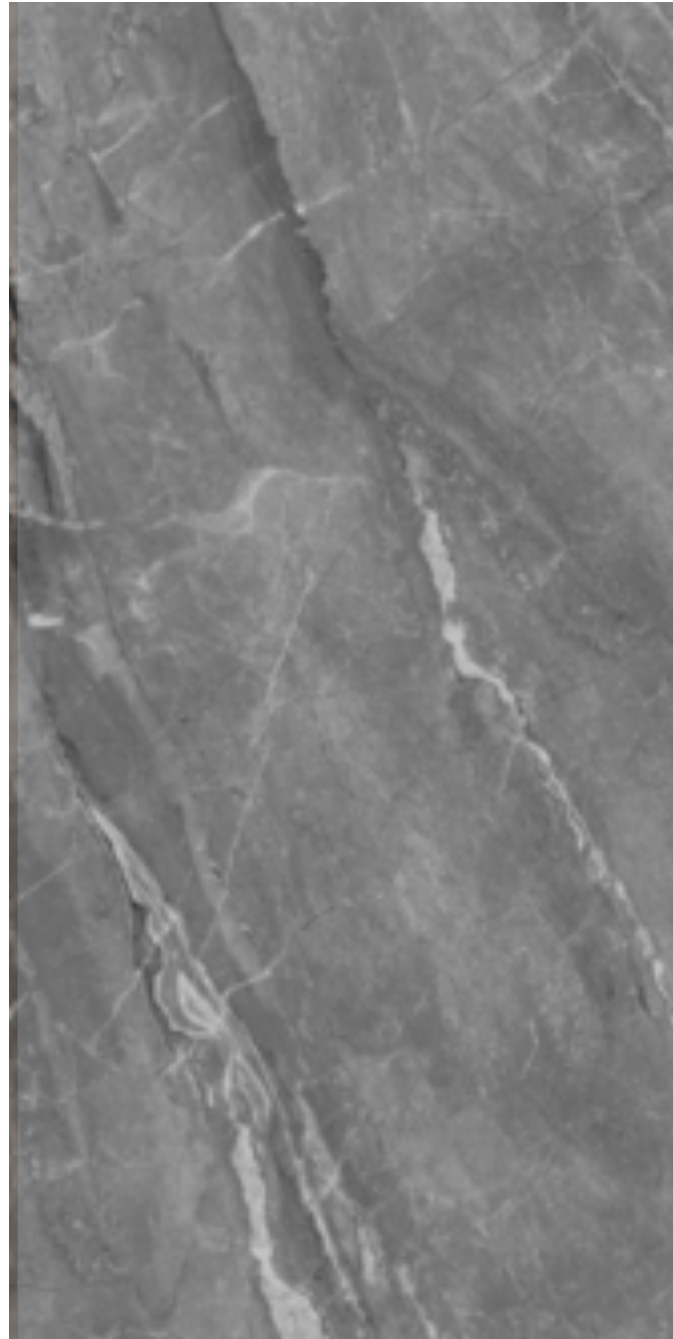

ASTONIA NERO PREMIUM POLISH

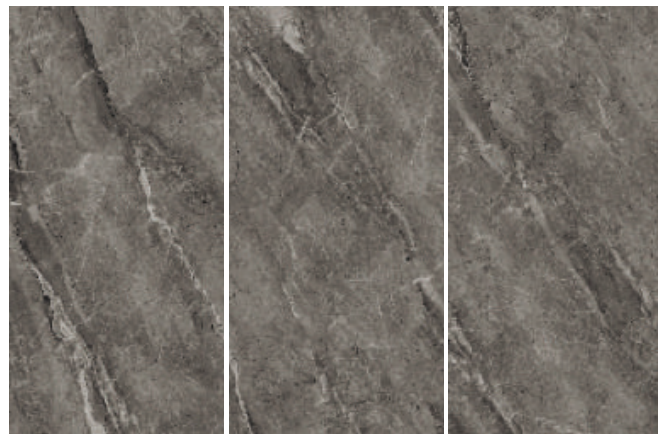

RANDOM - 3
THICKNESS - 9 MM



ASTONIA NERO | PREMIUM POLISH

THE ULTIMA
1200x2400 mm

360°
Click Here

- For wall application
- For floor application
- Fine detailing
- Stain resistant



BLOSSOM BEIGE DECOR **PREMIUM POLISH**

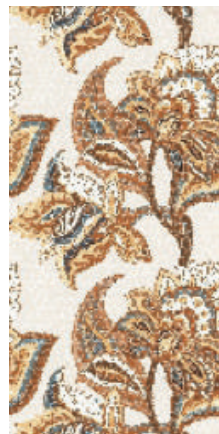

RANDOM - 1
THICKNESS - 9 MM



BLOSSOM BEIGE DECOR & ELEGANCE CREMA | PREMIUM POLISH & BEYOND

THE ULTIMA
1200x2400 mm

360°
Click Here

- For wall application
- For floor application
- Fine detailing
- Stain resistant



BLOSSOM BLUE DECOR PREMIUM POLISH

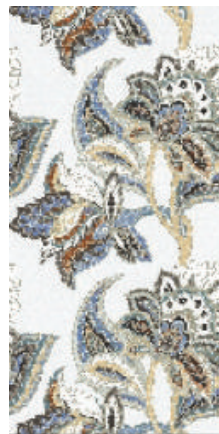

RANDOM - 1
THICKNESS - 9 MM



BLOSSOM BLUE DECOR & STONEX GREY | PREMIUM POLISH & BLEND

THE ULTIMA
1200x2400 mm



- For wall application
- For floor application
- Fine detailing
- Stain resistant

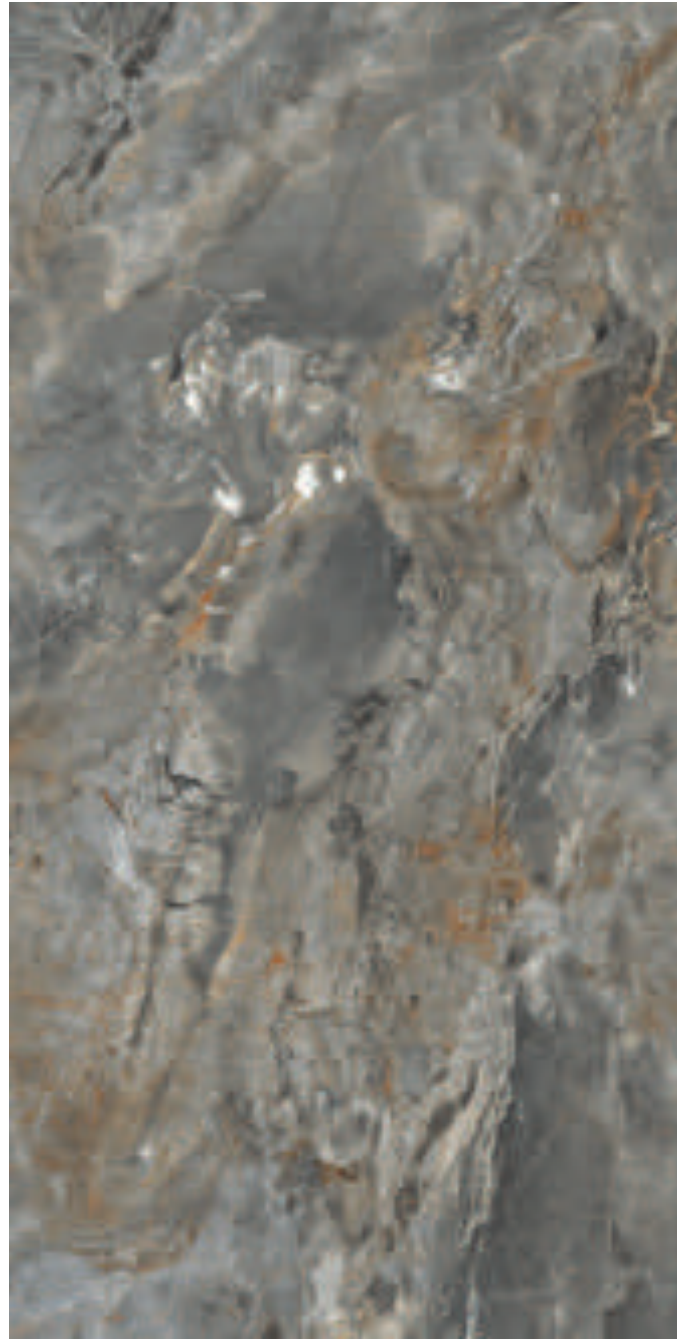

BOLVIA GRIS **PREMIUM POLISH**

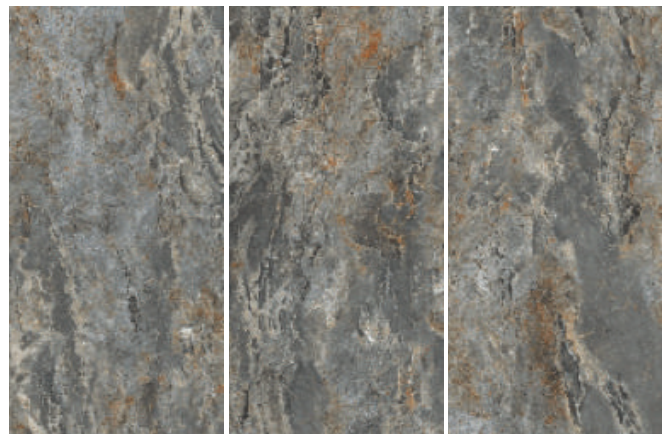

RANDOM - 4
THICKNESS - 9 MM



BOLVIA GRIS | PREMIUM POLISH

THE ULTIMA
1200x2400 mm

360°
Click Here

- For wall application
- For floor application
- Fine detailing
- Stain resistant



CHARCOAL NERO PREMIUM POLISH



RANDOM - 3
THICKNESS - 9 MM



CHARCOAL NERO | PREMIUM POLISH

THE ULTIMA
1200x2400 mm

360°
Click Here

- For wall application
- For floor application
- Fine detailing
- Stain resistant

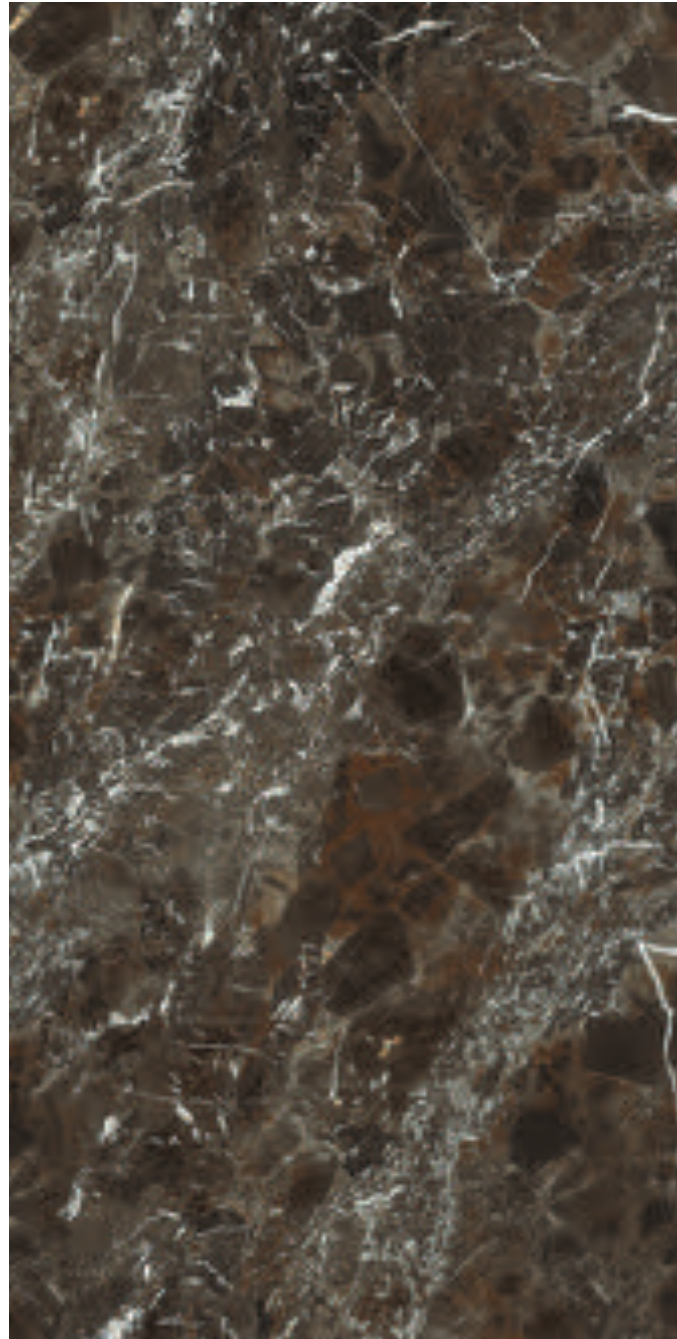

EARTHSTORM BRONCE PREMIUM POLISH

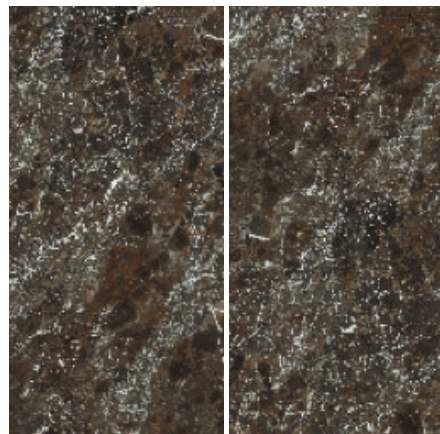



RANDOM - 2
THICKNESS - 9 MM



EARTHSTORM BRONCE | PREMIUM POLISH

THE ULTIMA
1200x2400 mm

360°
Click Here

-  For wall application
-  For floor application
-  Fine detailing
-  Stain resistant



FUSION VERDE

PREMIUM POLISH



RANDOM - 2
THICKNESS - 9 MM



THE ULTIMA
1200x2400 mm

360°
Click Here

- For wall application
- For floor application
- Fine detailing
- Stain resistant

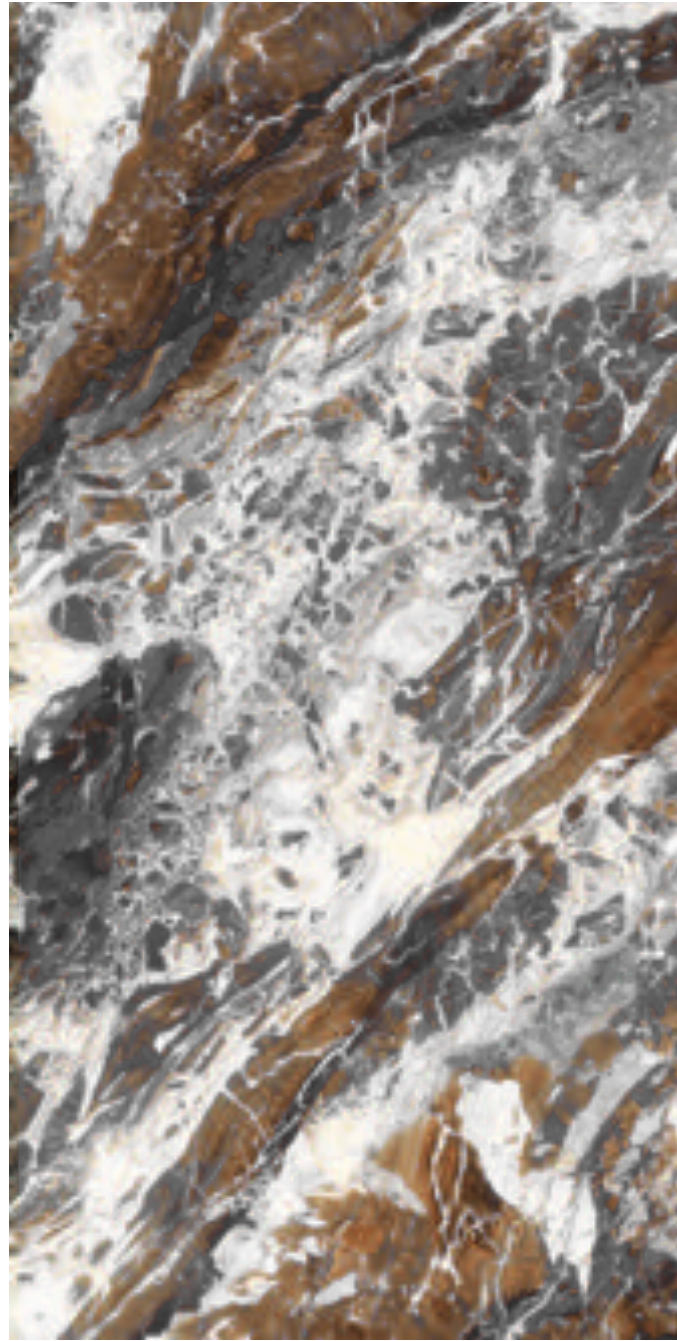

BOOK MATCH

LUCIFER BROWN

PREMIUM POLISH

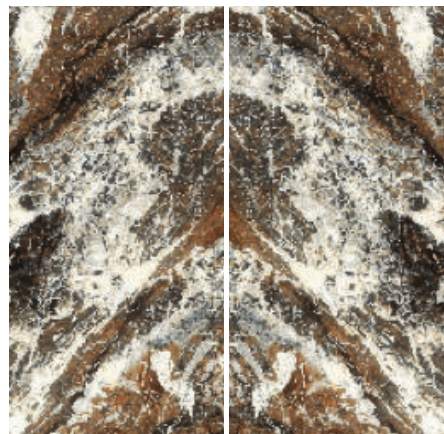

RANDOM - 2
THICKNESS - 9 MM



LUCIFER BROWN (BOOK MATCH) & ONYX BEIGE | PREMIUM POLISH & SUPERWHITE

THE ULTIMA
1200x2400 mm

360°
Click Here

- For wall application
- For floor application
- Fine detailing
- Stain resistant

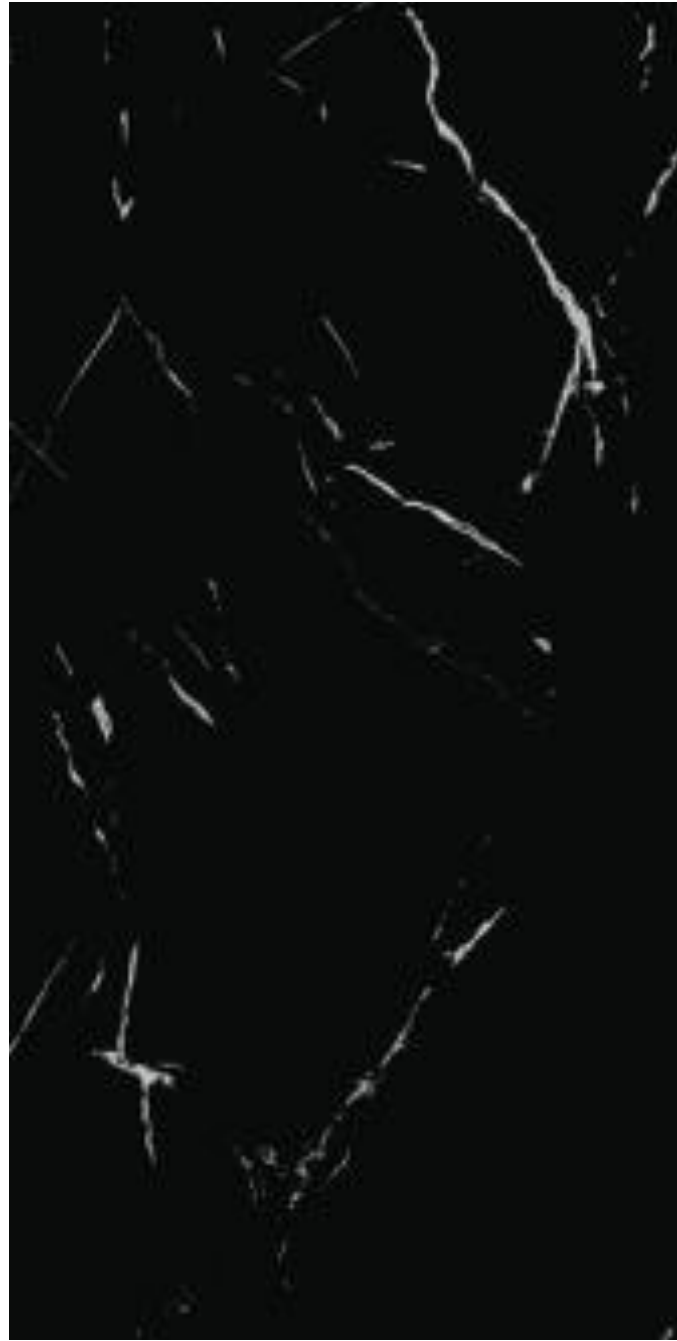

MARKINO NERO PREMIUM POLISH

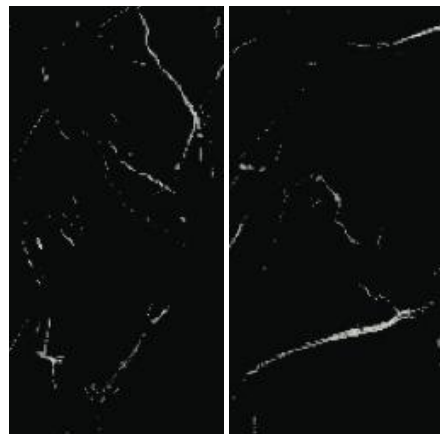

RANDOM - 2
THICKNESS - 9 MM



MARKINO NERO | PREMIUM POLISH

THE ULTIMA
1200x2400 mm



- For wall application
- For floor application
- Fine detailing
- Stain resistant

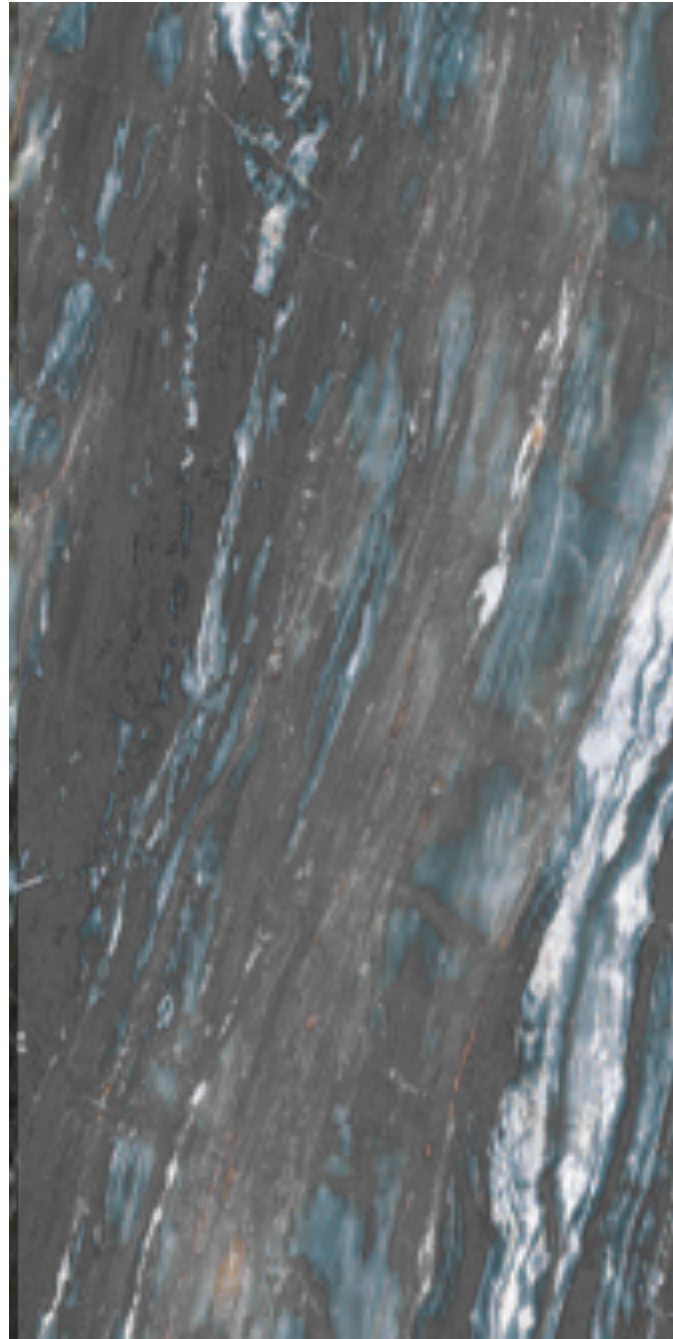

PACIFIC VERDE

PREMIUM POLISH

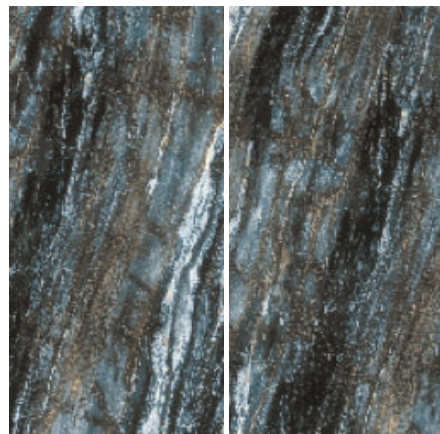

RANDOM - 2
THICKNESS - 9 MM



PACIFIC VERDE | PREMIUM POLISH

THE ULTIMA
1200x2400 mm

360°
Click Here

- For wall application
- For floor application
- Fine detailing
- Stain resistant



PARADISE AZUL PREMIUM POLISHED

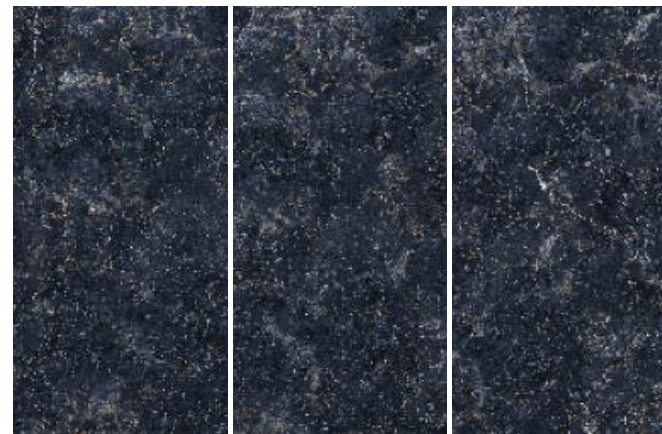

RANDOM - 3
THICKNESS - 9 MM



PARADISE AZUL & METRO MIST | PREMIUM POLISH & POLISH

THE ULTIMA
1200x2400 mm



- For wall application
- For floor application
- Fine detailing
- Stain resistant

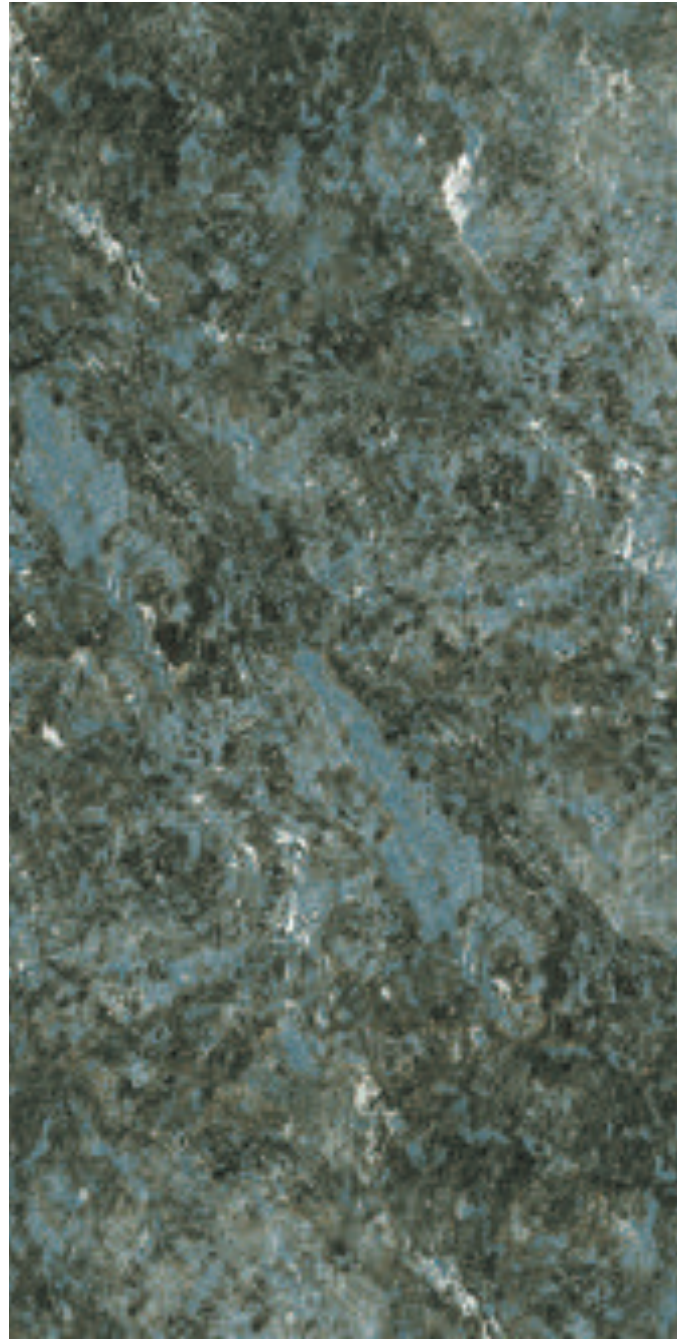

PEARL GREEN PREMIUM POLISH

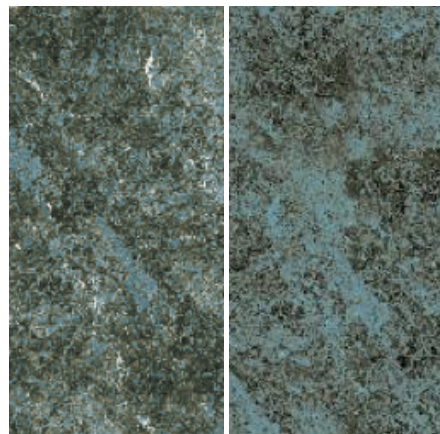

RANDOM - 2
THICKNESS - 9 MM



PEARL GREEN | PREMIUM POLISH

THE ULTIMA
1200x2400 mm

360°
Click Here

- For wall application
- For floor application
- Fine detailing
- Stain resistant



PIETRA BRONCE PREMIUM POLISH

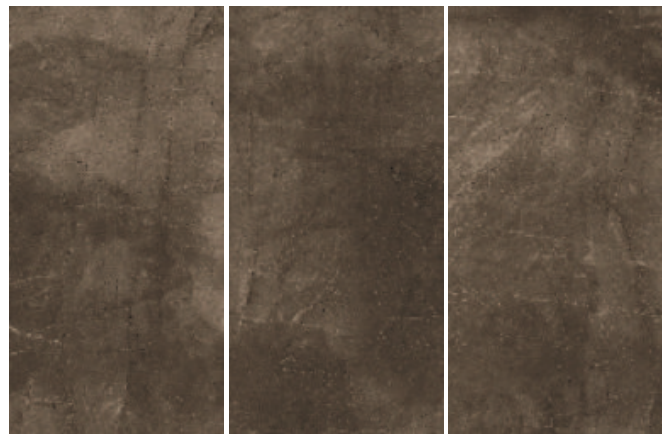



RANDOM - 3
THICKNESS - 9 MM



PIETRA BRONCE | PREMIUM POLISH

THE ULTIMA
1200x2400 mm

360°
Click Here

-  For wall application
-  For floor application
-  Fine detailing
-  Stain resistant

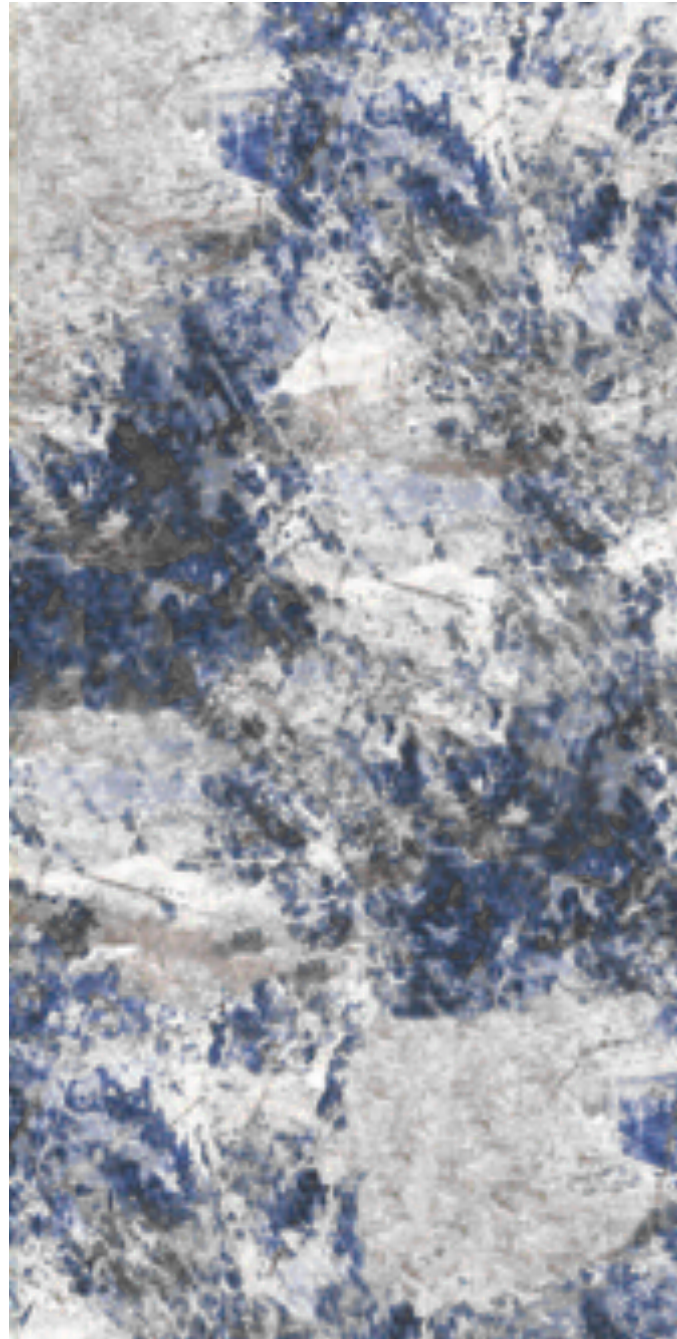

ROYAL AZUL PREMIUM POLISH

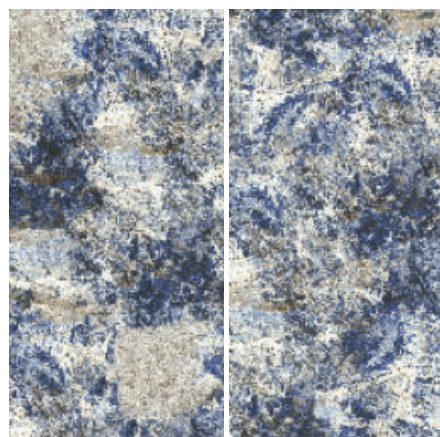





RANDOM - 2
THICKNESS - 9 MM



ROYAL AZUL | PREMIUM POLISH

THE ULTIMA
1200x2400 mm

360°
Click Here

-  For wall application
-  For floor application
-  Fine detailing
-  Stain resistant



ADMIRAL BROWN

POLISH



RANDOM - 3
THICKNESS - 9 MM



ADMIRAL BROWN | POLISH

THE ULTIMA
1200x2400 mm



- For wall application
- For floor application
- Fine detailing
- Stain resistant

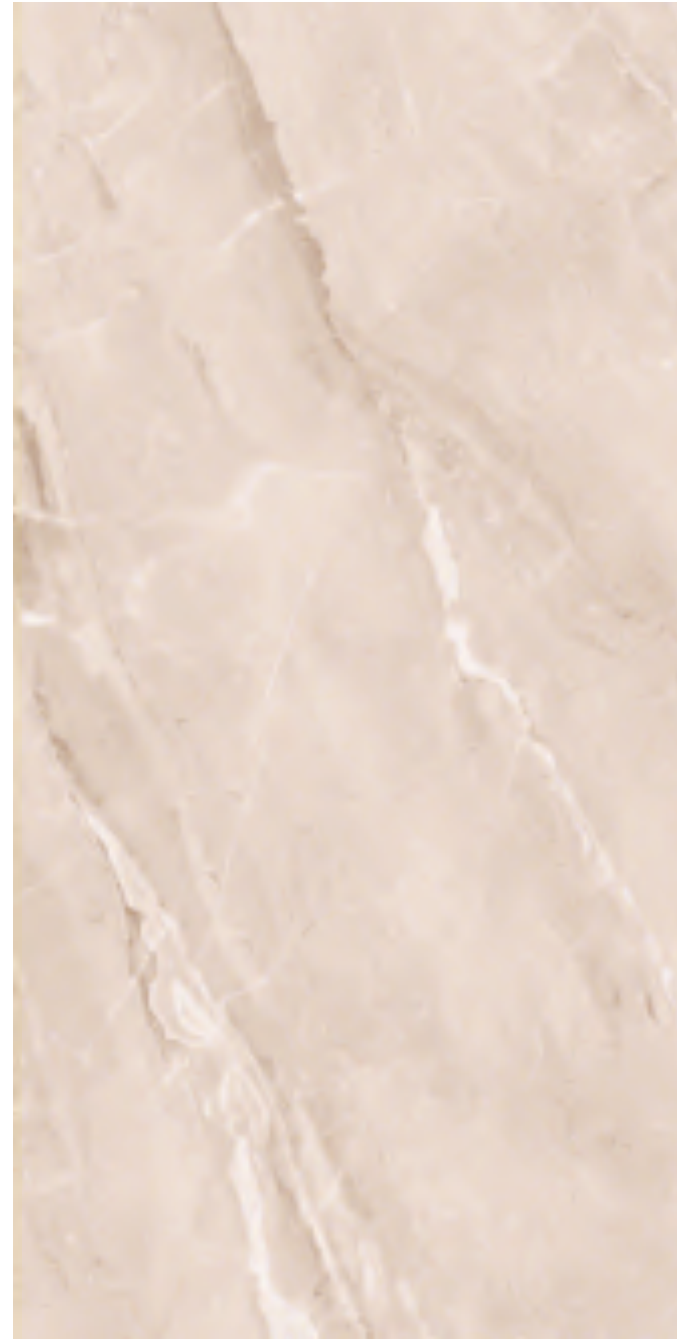

ASTONIA BEIGE

POLISH



RANDOM - 3
THICKNESS - 9 MM



ASTONIA BEIGE | POLISH

THE ULTIMA
1200x2400 mm

360°
Click Here

- For wall application
- For floor application
- Fine detailing
- Stain resistant



ASTONIA GREY

POLISH



RANDOM - 3
THICKNESS - 9 MM



ASTONIA GREY | POLISH

THE ULTIMA
1200x2400 mm

360°
Click Here

- For wall application
- For floor application
- Fine detailing
- Stain resistant



BOLVIA GREY

POLISH



RANDOM - 4
THICKNESS - 9 MM



BOLVIA GREY | POLISH

THE ULTIMA
1200x2400 mm

360°
Click Here

- For wall application
- For floor application
- Fine detailing
- Stain resistant



BRECCIA AZURE

POLISH







RANDOM - 3
THICKNESS - 9 MM



BRECCIA AZURE | POLISH

THE ULTIMA
1200x2400 mm

360°
Click Here

-  For wall application
-  For floor application
-  Fine detailing
-  Stain resistant

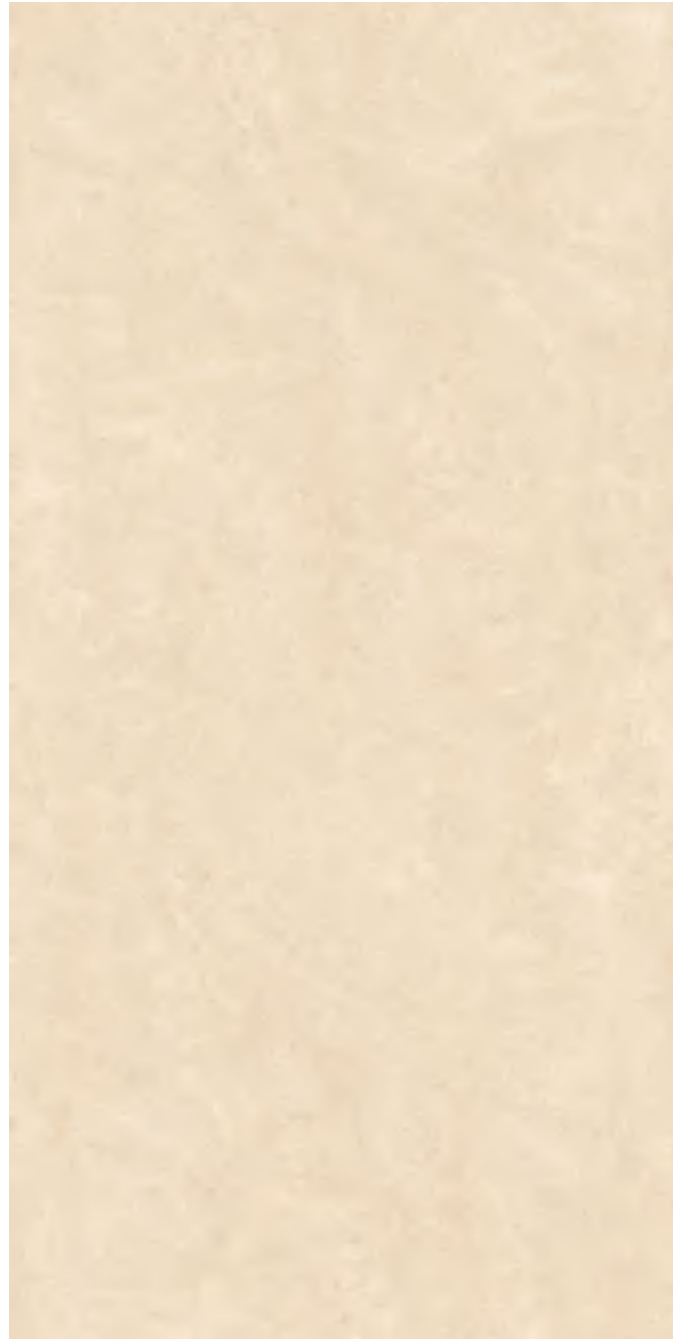

ELEGANCE CREMA

POLISH



RANDOM - 2
THICKNESS - 9 MM



ELEGANCE CREMA | POLISH

THE ULTIMA
1200x2400 mm



- For wall application
- For floor application
- Fine detailing
- Stain resistant



ESPERADO GREY

POLISH



RANDOM - 3
THICKNESS - 9 MM



ESPERADO GREY | POLISH

THE ULTIMA
1200x2400 mm

360°
Click Here

- For wall application
- For floor application
- Fine detailing
- Stain resistant

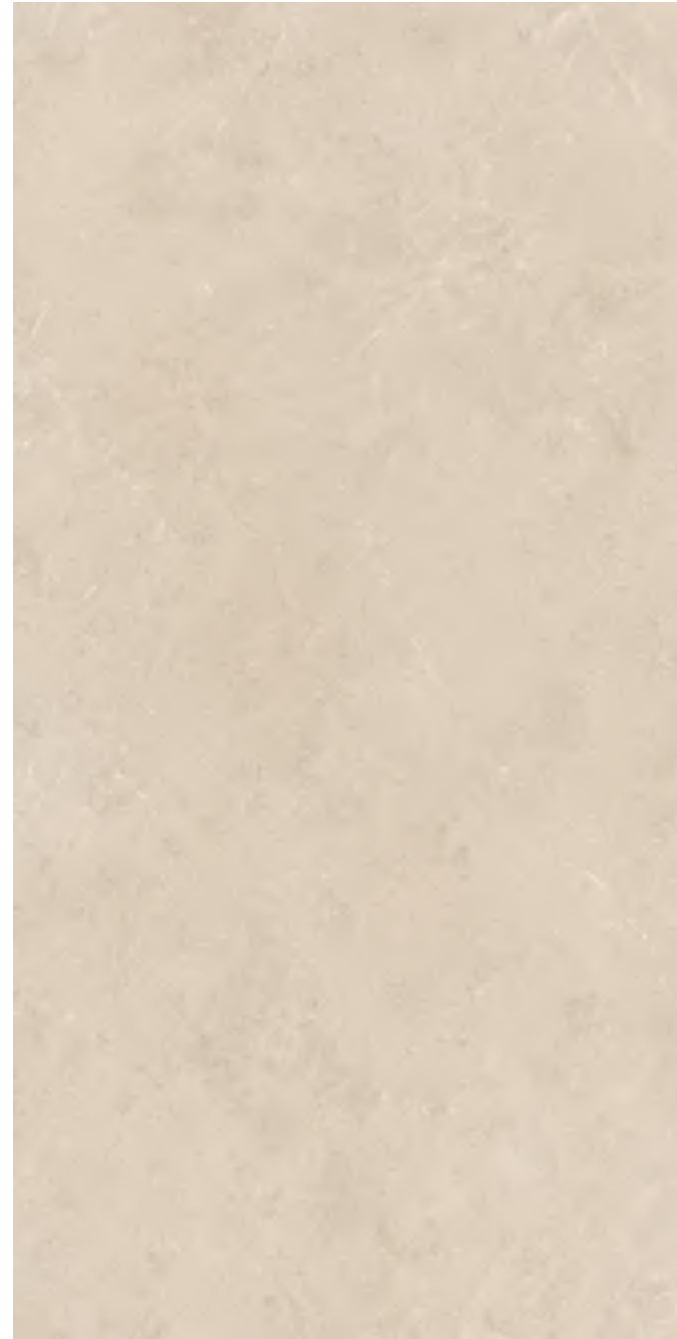

GOZZIO BEIGE

POLISH



RANDOM - 3
THICKNESS - 9 MM



GOZZIO BEIGE | POLISH

THE ULTIMA
1200x2400 mm

360°
Click Here

- For wall application
- For floor application
- Fine detailing
- Stain resistant



HELUX GREY

POLISH



RANDOM - 4
THICKNESS - 9 MM



HELUX GREY | POLISH

THE ULTIMA
1200x2400 mm



- For wall application
- For floor application
- Fine detailing
- Stain resistant



HORIZON GREY

POLISH



RANDOM - 2
THICKNESS - 9 MM



HORIZON GREY | POLISH

THE ULTIMA
1200x2400 mm



- For wall application
- For floor application
- Fine detailing
- Stain resistant

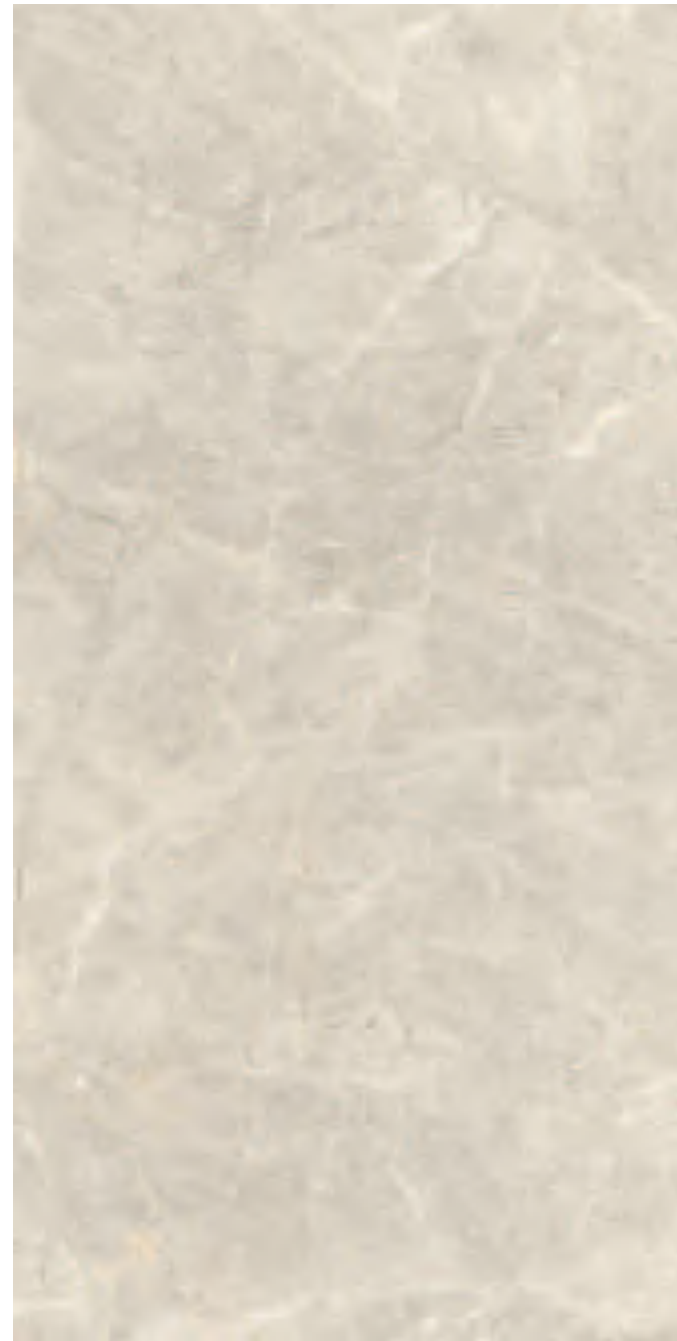

INTEL CREMA

POLISH



RANDOM - 3
THICKNESS - 9 MM



INTEL CREMA & BOLVIA GRIS | POLISH & PREMIUM POLISH

THE ULTIMA
1200x2400 mm

360°
Click Here

- For wall application
- For floor application
- Fine detailing
- Stain resistant



METRO MIST

POLISH



RANDOM - 3
THICKNESS - 9 MM



METRO MIST | POLISH

THE ULTIMA
1200x2400 mm

360°
Click Here

- For wall application
- For floor application
- Fine detailing
- Stain resistant



PAVIT GREY POLISH



RANDOM - 3
THICKNESS - 9 MM



PAVIT GREY | POLISH

THE ULTIMA
1200x2400 mm

360°
Click Here

- For wall application
- For floor application
- Fine detailing
- Stain resistant



PRESTIGE MARFIL

POLISH



RANDOM - 2
THICKNESS - 9 MM



PRESTIGE MARFIL | POLISH

THE ULTIMA
1200x2400 mm



- For wall application
- For floor application
- Fine detailing
- Stain resistant

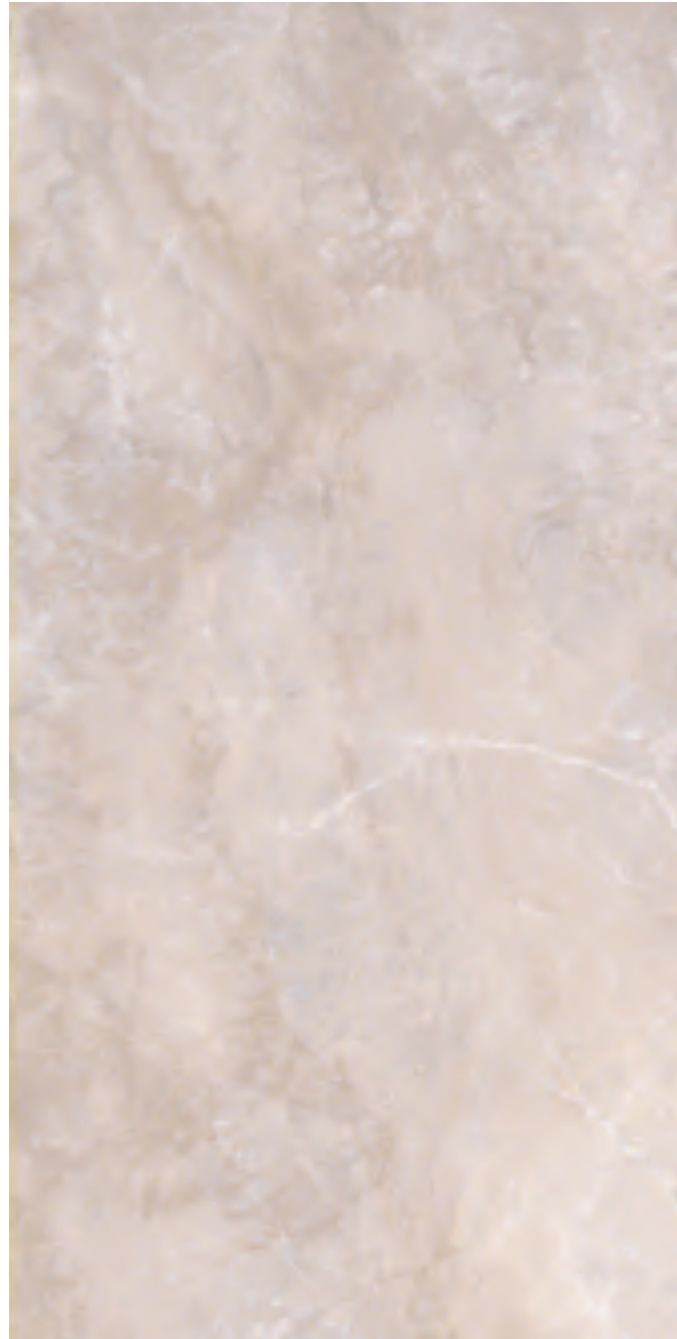

TRIANA CREMA

POLISH



RANDOM - 3
THICKNESS - 9 MM



TRIANA CREMA | POLISH

THE ULTIMA
1200x2400 mm



- For wall application
- For floor application
- Fine detailing
- Stain resistant



VATICAN TAUPE

POLISH



RANDOM - 3
THICKNESS - 9 MM



VATICAN TAUPE | POLISH

THE ULTIMA
1200x2400 mm

360°
Click Here

- For wall application
- For floor application
- Fine detailing
- Stain resistant

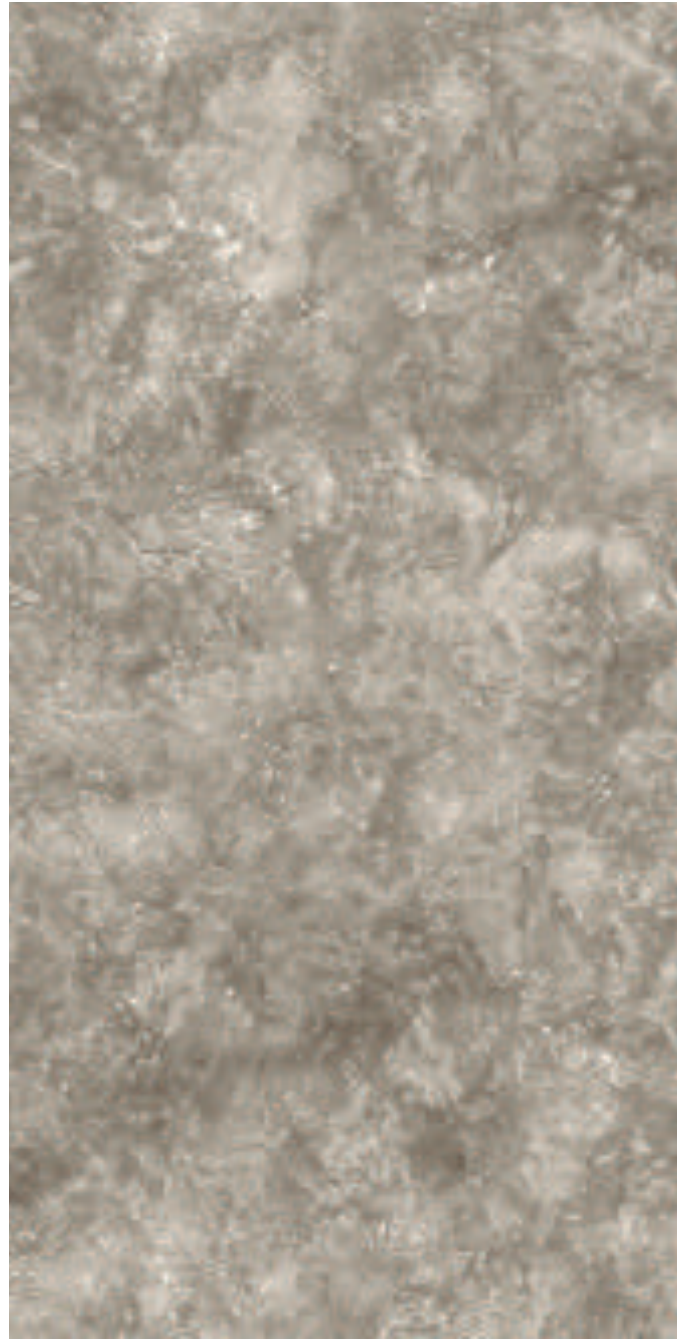

WILLIAM GREY

POLISH



RANDOM - 2
THICKNESS - 9 MM



WILLIAM GREY | POLISH

THE ULTIMA
1200x2400 mm

360°
Click Here

- For wall application
- For floor application
- Fine detailing
- Stain resistant



LITHIO BEIGE

MARBLETECH



RANDOM - 2
THICKNESS - 9 MM



LITHIO BEIGE | MARBLETECH

THE ULTIMA
1200x2400 mm

360°
Click Here

- For wall application
- For floor application
- Fine detailing
- Stain resistant

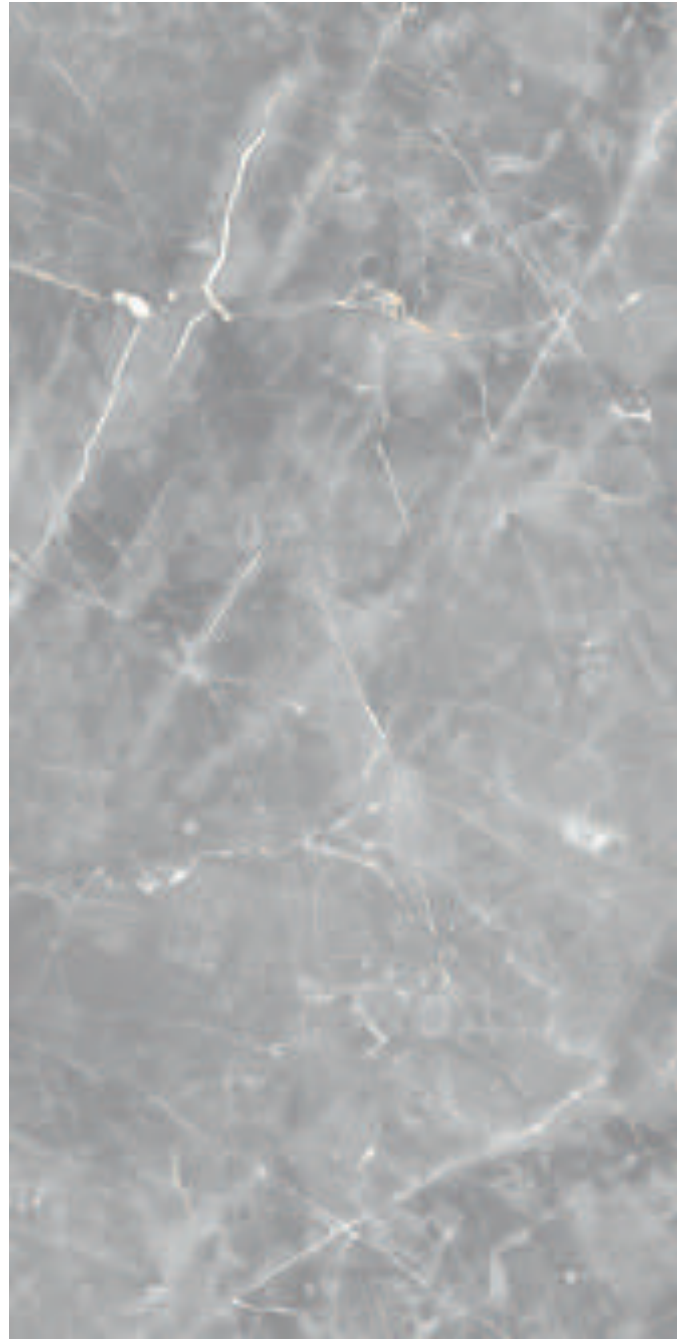

BRISBANE GREY

MARBLETECH

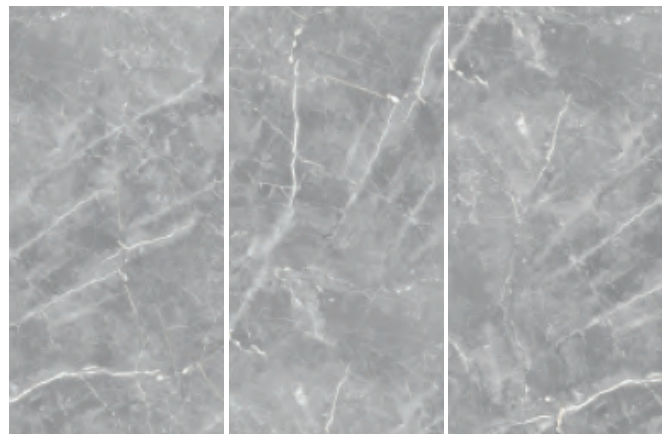

RANDOM - 3
THICKNESS - 9 MM



BRISBANE GREY | MARBLETECH

THE ULTIMA
1200x2400 mm



- For wall application
- For floor application
- Fine detailing
- Stain resistant



EMPERADOR GREY

MARBLETECH



RANDOM - 2
THICKNESS - 9 MM



THE ULTIMA
1200x2400 mm



- For wall application
- For floor application
- Fine detailing
- Stain resistant

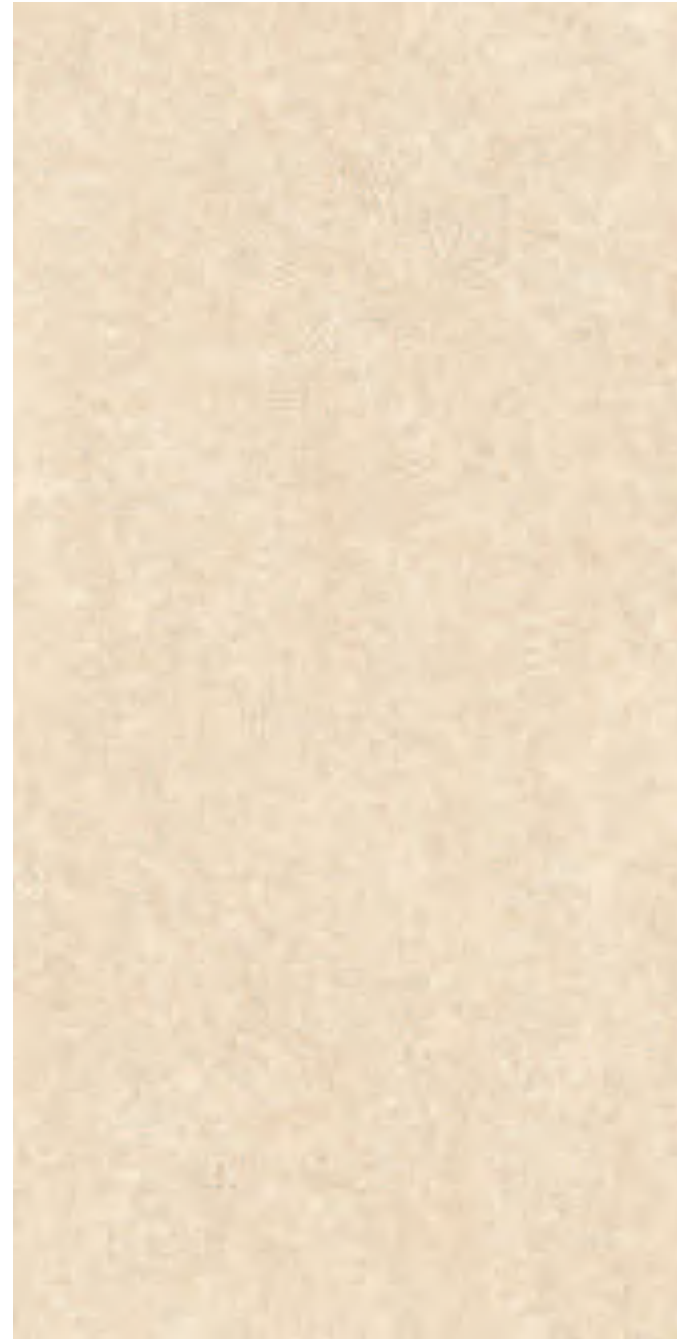

ELEGANCE CREMA

BEYOND



RANDOM - 2
THICKNESS - 9 MM



ELEGANCE CREMA | BEYOND

THE ULTIMA
1200x2400 mm



- For wall application
- For floor application
- Fine detailing
- Stain resistant



GENUS MARFIL

BEYOND



RANDOM - 3
THICKNESS - 9 MM



GENUS MARFIL | BEYOND

THE ULTIMA
1200x2400 mm



- For wall application
- For floor application
- Fine detailing
- Stain resistant



GENUS TAUPE

BEYOND

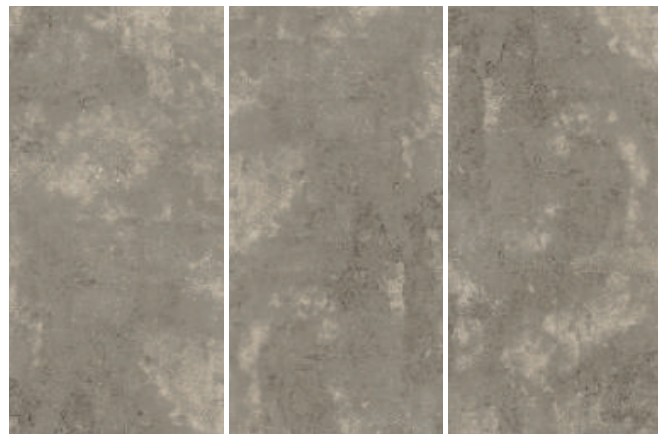

RANDOM - 3
THICKNESS - 9 MM



GENUS TAUPE | BEYOND

THE ULTIMA
1200x2400 mm

360°
Click Here

- For wall application
- For floor application
- Fine detailing
- Stain resistant



PIETRA BRONCE

BEYOND

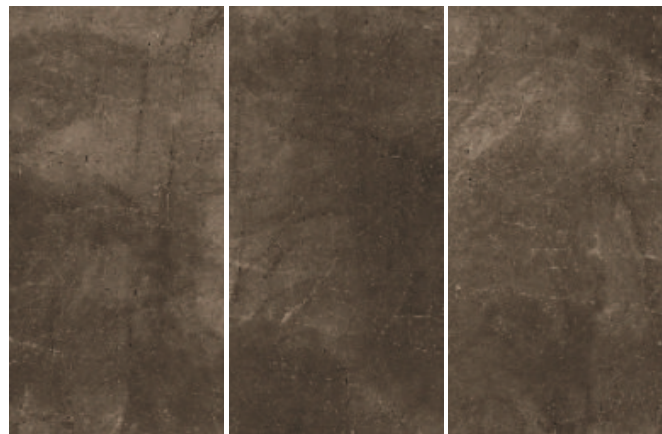

RANDOM - 3
THICKNESS - 9 MM



PIETRA BRONCE | BEYOND

THE ULTIMA
1200x2400 mm



- For wall application
- For floor application
- Fine detailing
- Stain resistant



PAVIT GREY

BEYOND



RANDOM - 3
THICKNESS - 9 MM



PAVIT GREY | BEYOND

THE ULTIMA
1200x2400 mm



- For wall application
- For floor application
- Fine detailing
- Stain resistant

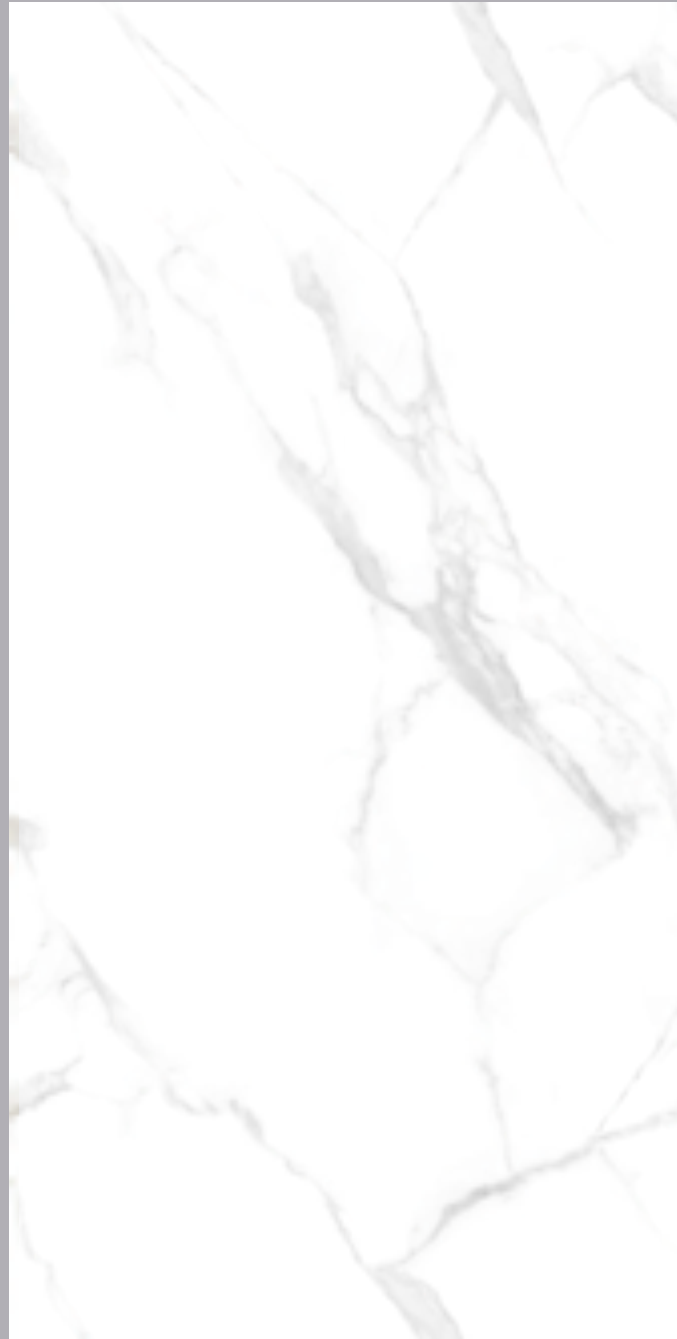

CONTINUOUS GRAPHIC

SATUARIO LUXE

BEYOND

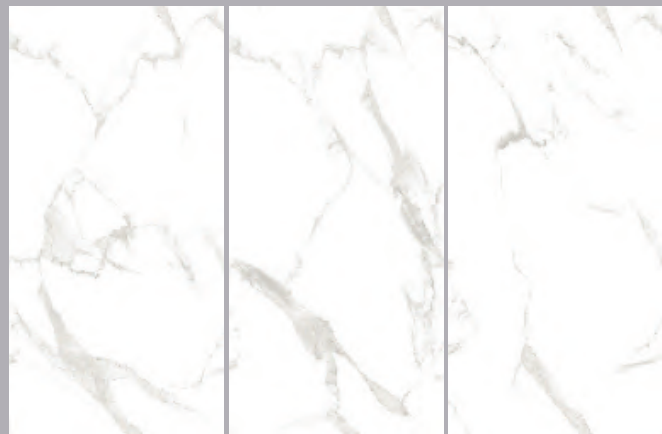



RANDOM - 4
THICKNESS - 9 MM



THE ULTIMA
1200x2400 mm

360°
Click Here

-  For wall application
-  For floor application
-  Fine detailing
-  Stain resistant

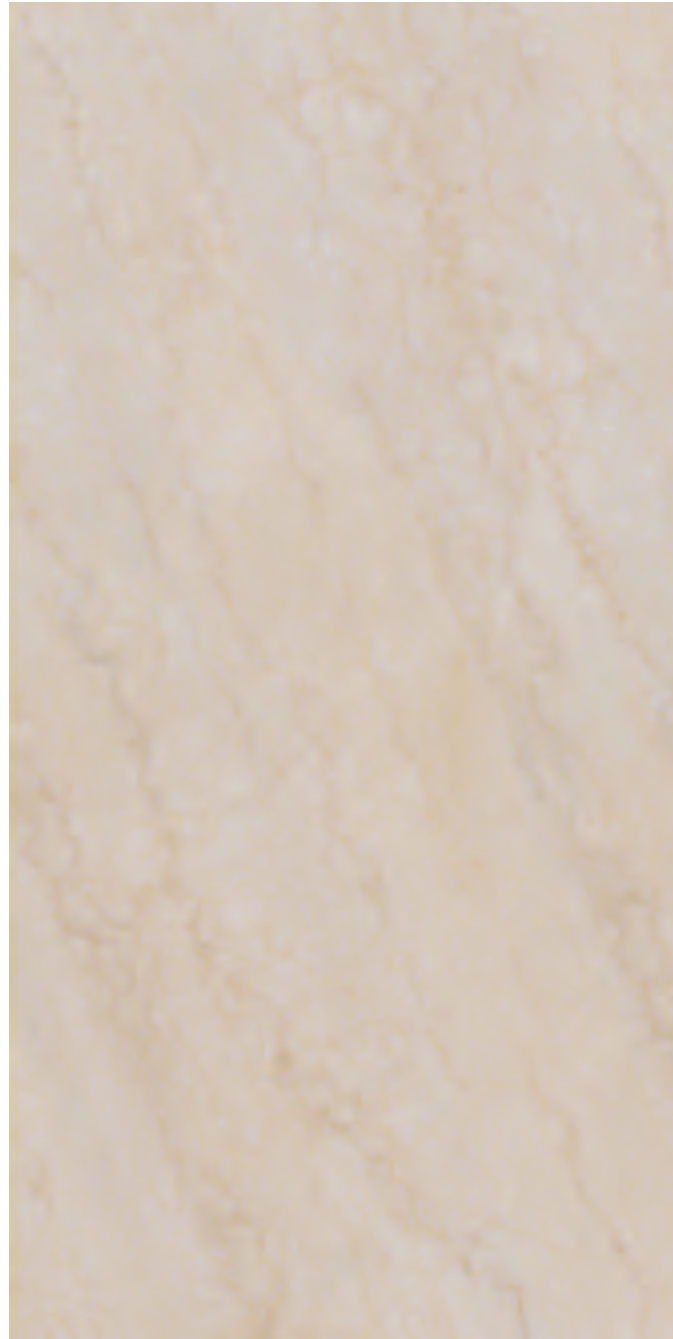

BOTTOCINO

BLEND



RANDOM - 2
THICKNESS - 9 MM



BOTTOCINO | BLEND

THE ULTIMA
1200x2400 mm

360°
Click Here

- For wall application
- For floor application
- Fine detailing
- Stain resistant

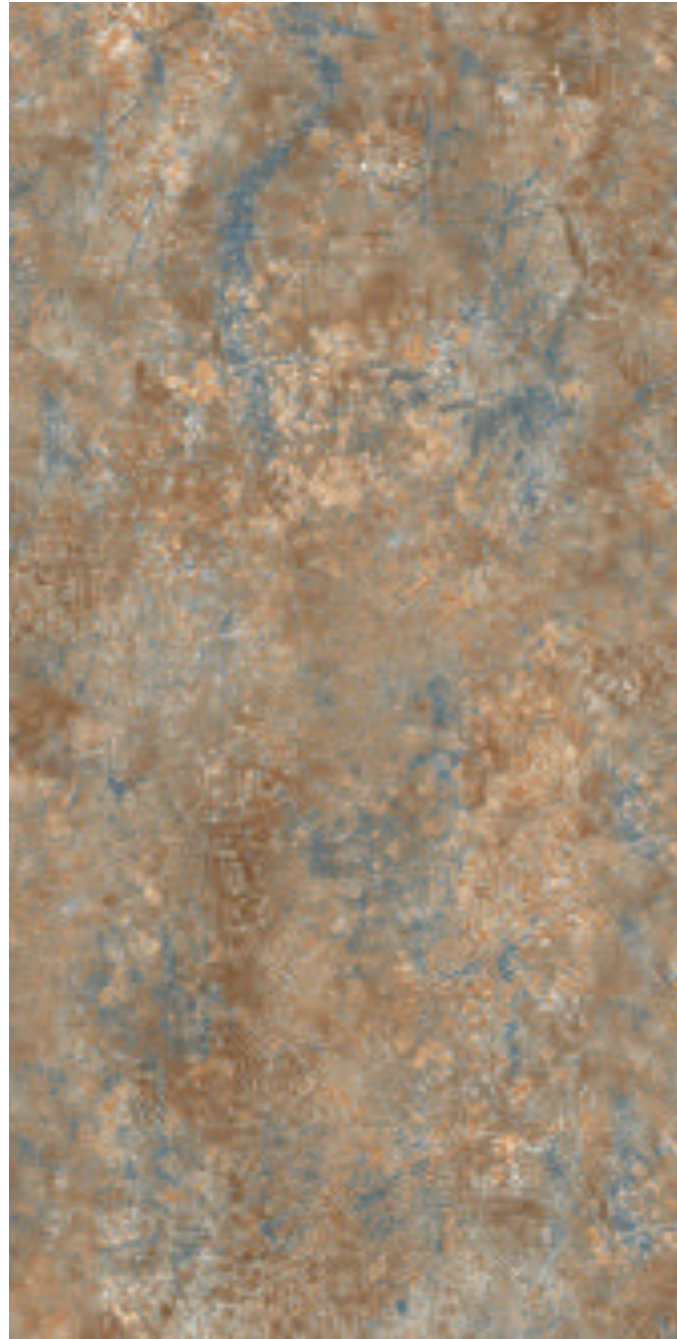

EDEN VERDE

BLEND

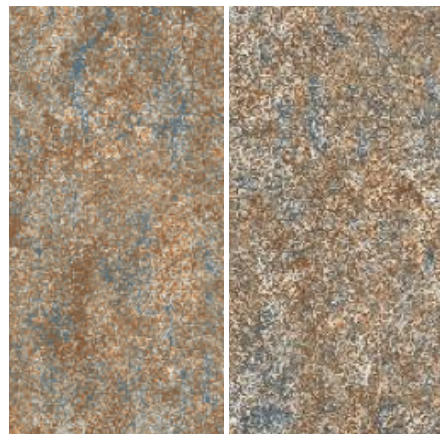

RANDOM - 2
THICKNESS - 9 MM



EDEN VERDE | BLEND

THE ULTIMA
1200x2400 mm

360°
Click Here

-  For wall application
-  For floor application
-  Fine detailing
-  Stain resistant



STONEX GREY

BLEND





RANDOM - 2
THICKNESS - 9 MM



STONEX GREY | BLEND

THE ULTIMA
1200x2400 mm

360°
Click Here

-  For wall application
-  For floor application
-  Fine detailing
-  Stain resistant



STONEX GRIS BLEND

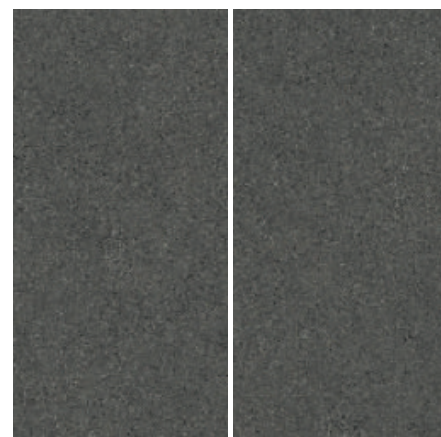

RANDOM - 2
THICKNESS - 9 MM



STONEX GRIS | BLEND

THE ULTIMA
1200x2400 mm



- For wall application
- For floor application
- Fine detailing
- Stain resistant



PERTH TAUPE

MATT



RANDOM - 2
THICKNESS - 9 MM



PERTH TAUPE | MATT

THE ULTIMA
1200x2400 mm



- For wall application
- For floor application
- Fine detailing
- Stain resistant



RESINO GREY

MATT

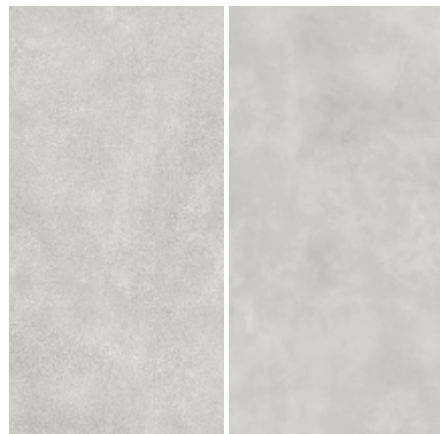



RANDOM - 2
THICKNESS - 9 MM



RESINO GREY | MATT

THE ULTIMA
1200x2400 mm

360°
Click Here

-  For wall application
-  For floor application
-  Fine detailing
-  Stain resistant



RESINO GRIS MATT



RANDOM - 2
THICKNESS - 9 MM



RESINO GRIS | MATT

TRANSPORTATION, HANDLING AND STORAGE OF ULTIMA SLAB

When transporting the Ultima slabs, they must be secured properly to avoid storage problems. If the tiles are transported over a short distance, the Ultima slabs should be kept vertically in the vehicle and at back side of slabs there should be proper packing or ply to avoid breakage. If the tiles are transported over a longer distance, they should be kept on an A shape frame, as shown in Fig A and B. With this method, we can avoid any breakage of slabs during transit.

Fig. A

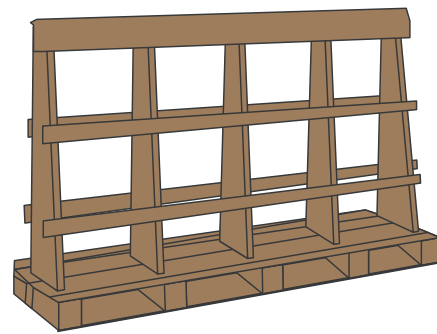
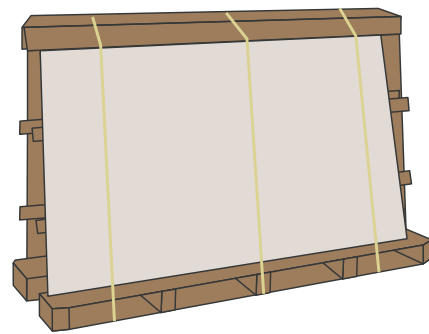

Fig. B



MANUAL HANDLING OF ULTIMA SLAB

When handling Ultima slabs manually, the primary tool used is the regular suction cup (Fig. A and B). Using these, workers can shift the tiles easily.

Fig. A

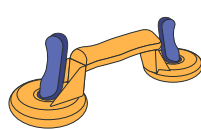
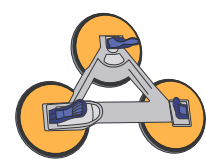
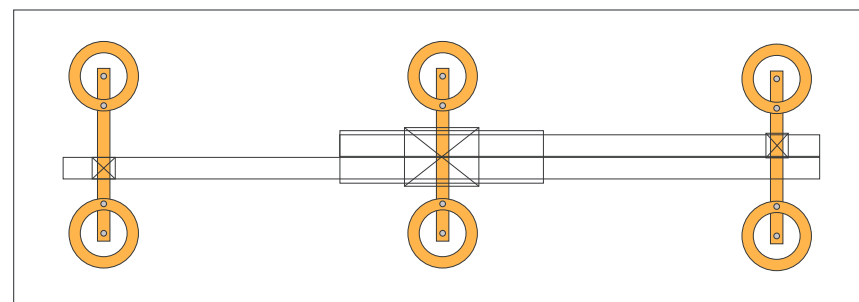

Fig. B



The suction cups should be attached to the face of the tile, not its rear side. The instructions by the manufacturers should always be followed.

Fig. C



If the surface of the slab is textured, the best way to handle the Ultima slabs manually is by using a Large Format Tile (LFT) Carrier System (Fig. C) with suction cups that hold the tile from all four sides. By using this method, workers can lift or shift the tiles easily without any damage and will require the manpower of two people.

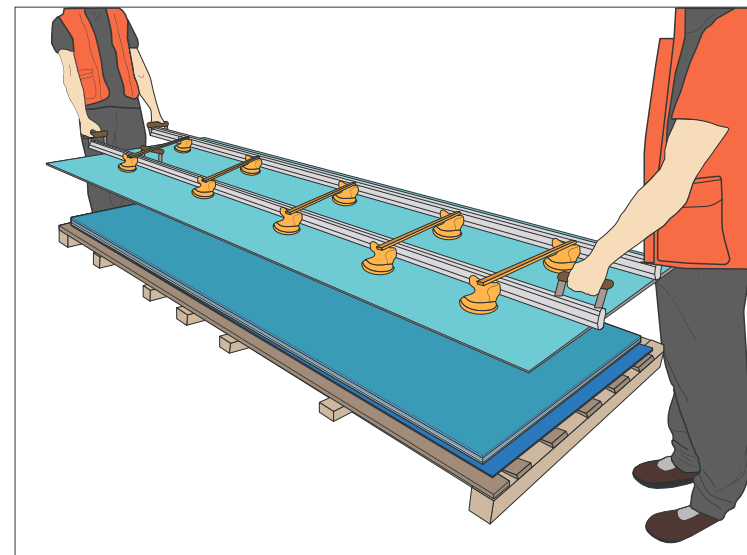
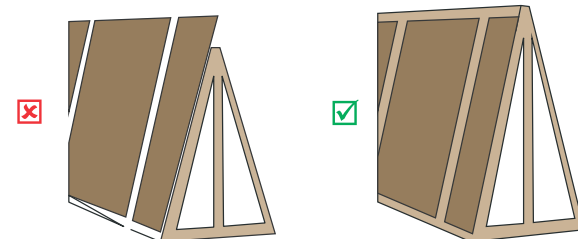

Fig. F

STORAGE

The Ultima slabs should be stored on A shape frame, made up of wood or steel with rubber lining, as shown below.

Fig. D



LAYING & FIXING

a) The Ultima slabs are very heavy, large-sized, and have sharp edges. So, it is important for the people transporting the tiles to wear protective gear like gloves during transportation. We also recommend the use of double or triple suction cups for a firm grip of the tile while ensuring the safety of the operator. Before transporting the tile, it should be thoroughly cleaned to get rid of any dust or moisture and make sure that the grip of the tile is not compromised. Then the suction cups should be placed on the face of the tile and be checked for how well they are stuck to the surface before lifting the tile.

To handle the large-sized slabs like Ultima slabs, we recommend using a special LFT carrier system with four suction cups.

b) The following points should be considered while laying the Ultima slabs:

1. The subfloor or the laying surface should be prepared properly before laying the Ultima slabs. The laying surface should be rigid, non-flexing, and capable of supporting the expected load with minimal or no deflection.
2. A leveled subfloor is extremely important to keep the Ultima slabs from cracking.
3. Provision of proper curing for the subfloor, for around 24 to 48 hours before tiling work.

For internal or external application, it is essential to select the appropriate cement-based, fiber-reinforced or ready-mixed adhesive to ensure that the Ultima slabs are properly fixed.

Fig. G

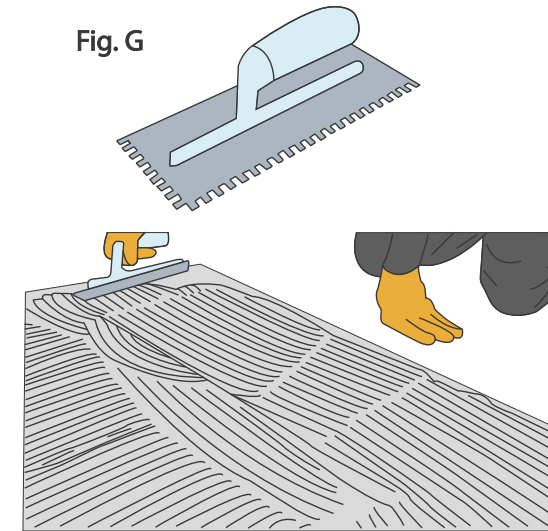

Fig. H

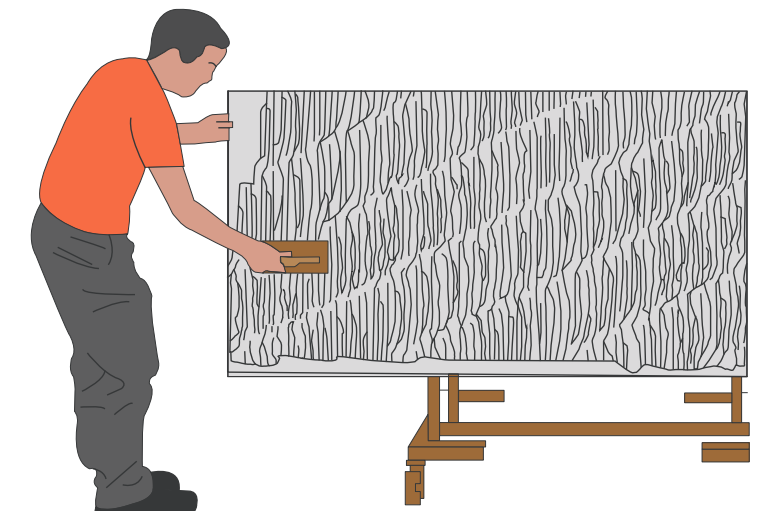
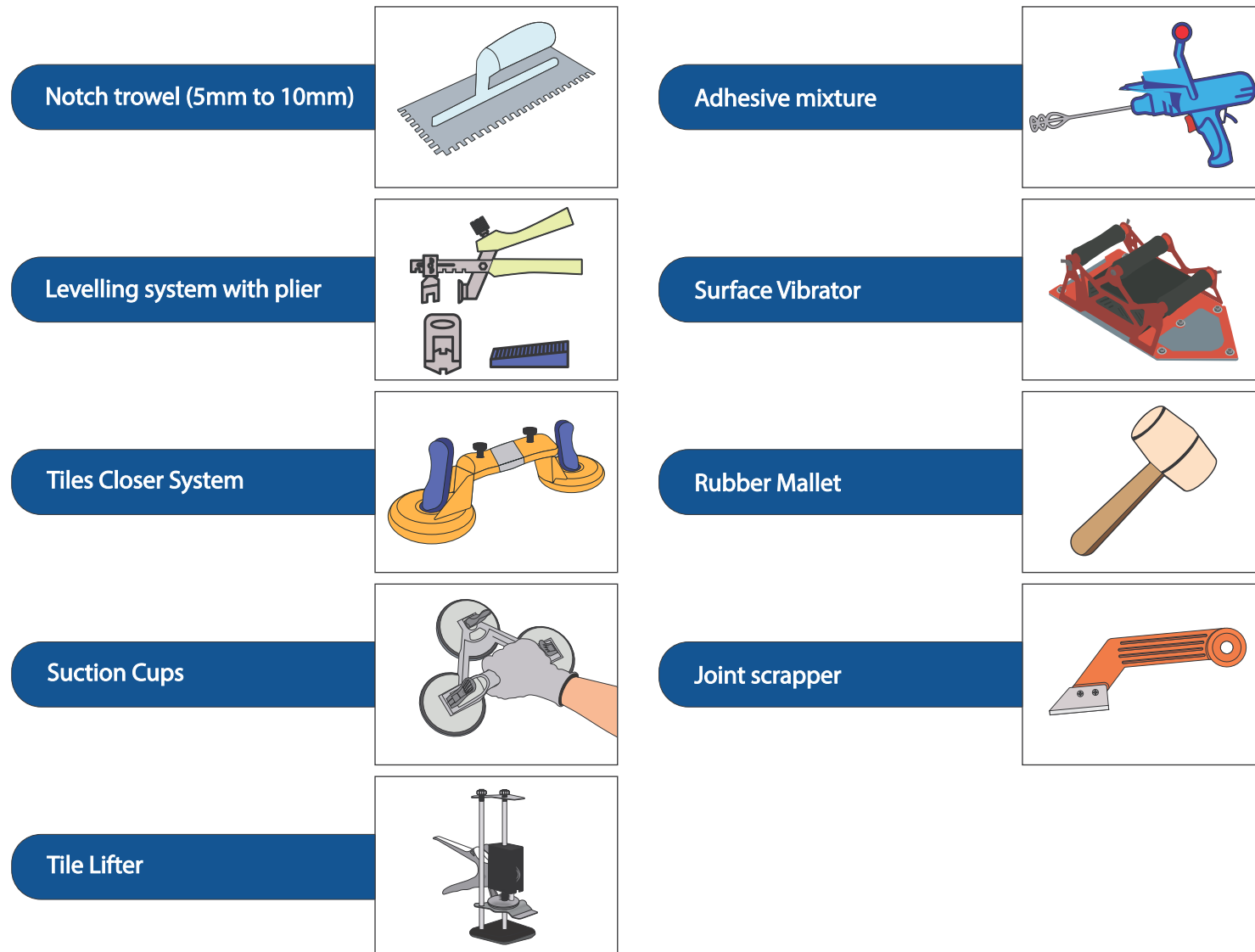

Fig. I

4. Once the subfloor is clean and ready, the adhesive should be spread evenly covering the entire area using a 10x10mm square notch trowel (Fig. G). The adhesive should cover 5cm to 10cm more than the size of the Ultima slabs. The adhesive should always be applied in stripes running parallel with the short edge to remove any air pockets or bubbles.
5. The Ultima slabs require back-buttering due to their large format. Back-buttering means applying a layer of adhesive at the back of the tile using a trowel (Fig. I). The Ultima slabs should be fixed on a handing frame with the use of suction cups in a vertical position, as shown in Fig. C.
6. To apply adhesive on the laying surface, a 10x10mm square notch trowel should be used whereas a 5x5mm square notch trowel should be used for back-buttering.
7. After fixing the Ultima slabs on a handing frame with the use of suction cups in a vertical position, it should be lowered slowly into a horizontal position and firmly pressed into the adhesive along with a surface vibrator or a rubber mallet.
8. Use a levelling system to avoid lippage and give a smooth and even surface at every joint. Levelling systems are available from 1mm to 10mm.
9. A closer system can be used to close the tiles nearer to each other and shift the tile slightly up and down at the time of fixing.
10. The backs of the slabs must be regularly checked to make sure that there is full contact between the adhesive and the tile surface. If a hollow sound is heard during fixing, the tile should be lifted again and provided with extra adhesive at that particular area to give proper strength to the tile.
11. After completing the tiling work, it is recommended to put a protection sheet on tiles until the completion of all civil work. It is recommended that the grouting work be done at the very last, after completing all civil work. We can use sanded grouts with hardener or epoxy grout, depending on the area of usage or as per instructions of the site in-charge.

TOOLS RECOMMENDED FOR ULTIMA SLABS



TILE CUTTING

Mark the portion to be cut out from the ends of the Ultima slab using a pencil. Then, properly position the cutting guide with a cutting carriage so that the references on the guide coincide with the lines marked on the slab. Lock the cutting. Guide with the cutting carriage in place using the suction cups. It is vital to keep the pressure and movement of the cutting carriage constant along the whole length of the cut to ensure correct scoring.

Score one end of the slab by 15cm pushing the cutting carriage towards the edge of the slab. Complete the scoring up to the opposite end of the slab.

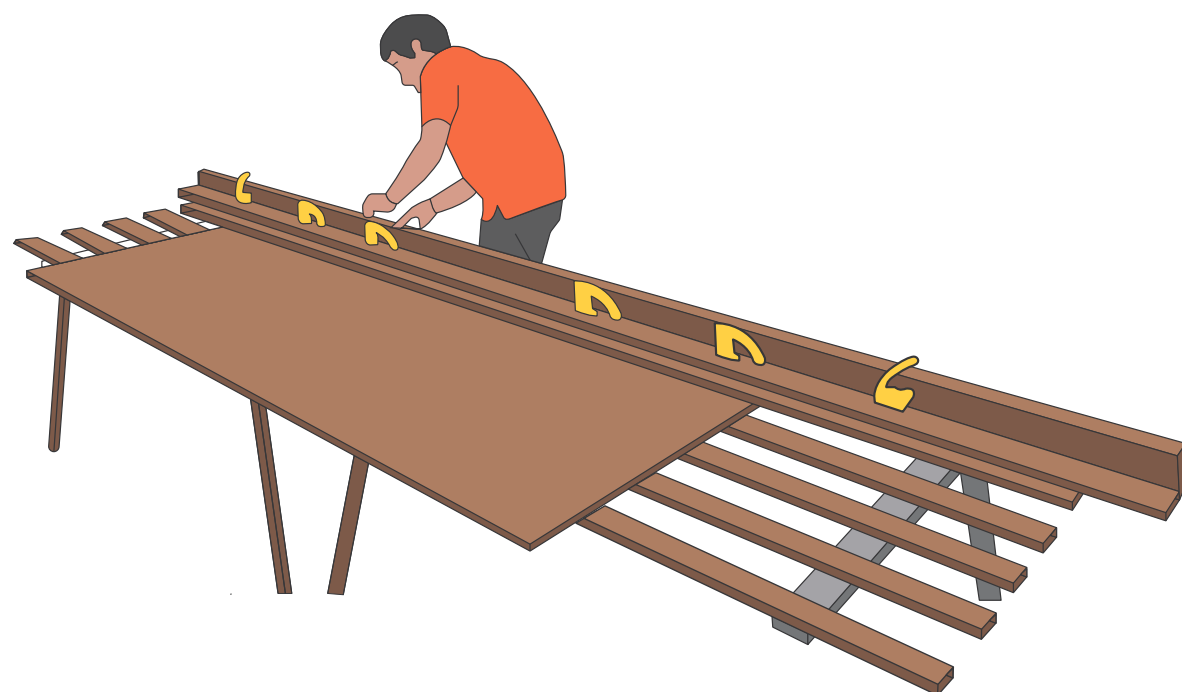

CLEANING

CLEANING AFTER LAYING

After laying the Ultima slabs on the floor or wall, it should be cleaned well to remove any residual grouting and the normal dirt acquired from building works.

A cementitious de-scaler can be used for cleaning the joints, as it is mildly acidic and does not emit harmful fumes, ensuring the safety of the user. In case of material laid with epoxy or resinous grouting, it is recommended to clean after laying with specific detergent or tile cleaner.



REGULAR MAINTENANCE

To clean the floor thoroughly, we recommend using a natural detergent with high cleaning power. In case of strong dirt that gets encrusted with time, we recommend consulting the following ways to find the perfect solution to every situation:

TYPE OF DIRT	PRODUCT
Cement, Metal tracer, rust	Cementitious descaler
Residuals, stains and halos of epoxy joints	Epoxy descaler
Grease, tire marks, colours, markers etc.	Non soap degrease
Graffiti	Acetone and anti-graffitis

RECOMMENDATIONS

Drying Process

Once the tiles have been grouted and the excess grout has been cleaned off, it is important to wait till the tiled surface is dried completely before cleaning. The recommended waiting time is 5 days, before cleaning or using the tiled surface.

Protecting from Liquid

The newly tiled surface must be protected from water and moisture while the adhesive and grouting materials are maturing and hardening. This is particularly important for outdoor spaces and areas, where there is a risk of freezing.

Damage Prevention

It is important to protect the newly tiled surface against mechanical or chemical damage resulting from subsequent work carried out by other professionals or due to later installations. Damage can be prevented by covering the floor tiles with thick cardboard or similar material.

Cleaning Products

For the final cleaning of the tiled surface, the products used should be compatible with the chemical resistance of the tiles. Avoid using solid detergents with abrasive particles and solutions containing hydrofluoric acid, which attacks the glaze and causes irreversible damage to the vitrified tile.

PACKING DETAILS

DIMENSIONS (MM)	NO. OF SLABS/BOX	COVERAGE AREA	WEIGHT / BOX (APPX.)
1200X2400	01	2.88 m ²	60 kg.

TECHNICAL SPECIFICATIONS

S.no.	Technical Characteristics	ISO 13006:2012/EN14411 Group B Standard's Requirement	Kajaria Eternity Tile's Specification	Test Method
Dimension & Surface Quality				
1	length	± 0.60 %	± 0.10 %	ISO 10545-2
2	Thickness	± 5.00 %	± 3.00 %	ISO 10545-2
3	Straightness in side	± 0.50 %	± 0.10 %	ISO 10545-2
4	Rectangularity	± 0.50 %	± 0.10 %	ISO 10545-2
5	Surface flatness	± 0.50 %	± 0.510 %	ISO 10545-2
6	Surface quality	Declared by Manu.	95~105 %	ISO 2813 (Gloss Meter)
7	Glossiness (only Polished Products)	Min. 95% Tile Should Be Free From Defects	Min. 98% Tile Should Be Free From Defects	ISO 10545-2
Physical Characteristics				
8	Water absorption	E ≤ 0.5 %	E ≤ 0.5 %	ISO 10545-3
9	MOH'S hardness	≤ 6	≤ 6	ISO 10545-3
10	Moisture expansion	Nil	Nil	ISO 10545-10
11	Abrasion resistance	Declared by Manu.	Pei 3~5 (Declared on product)	ISO 10545-7
Mechanical Characteristics				
12	Flexural strength(MOR)	≥ 35N/mm ² (350kg/cm ²)	≥ 37N/mm ² (370kg/cm ²)	ISO 10545-4
13	Breaking strength	1300 Newton	2000 Newton	ISO 10545-4
14	Impact resistance	Declared by Manu.	No indentation or cracking	ISO 10545-5
Safety Characteristics				
15	Skid resistance (Dynamic Friction Coefficient)	≥ 0.4	≥ 0.4	ISO 10545-17
16	Density	≥ 2.0 gm/cc	≥ 2.3 gm/cc	DIN 51082
Thermo Photo Characteristics				
17	Thermal shock resistance	Resistant to 10 cycles	Pass Min. 10 cycles	ISO 10545-9
18	Frost resistance	Frost Proof	Need to comply with the standard	ISO 10545-12
19	Coefficient of Linear thermal Expansion	9x10 ⁻⁶ K-1	<5.86x10 ⁻⁶ K-1	ISO 10545-8
20	Color resistance to UV light	Resistant	Resistant	ISO 10545-16
Chemical Characteristics				
21	Chemical resistance: House Hold Chemicals & Swimming Pool Salts	Min. Class - GB	Confirm to Classes - GB	ISO 10545-13
22	Chemical resistance: Low Concentrations Acids & Alkalis	Min. Class - GIB	Confirm to Classes - GIB	ISO 10545-13
23	Chemical resistance: High Concentrations Acids & Alkalis	Min. Class - GHB	Confirm to Classes - GHB	ISO 10545-13
24	Stain resistance	Min. Class - 3	Min. Confirm to Class - 3	ISO 10545-14

Resistance to acids & alkalis (Exception of Hydrofluoric acid & its compounds)

** Vitrified tiles have resistance to most of the stains / chemicals but, it is recommended to take due care while laying and for day-to-day maintenance.

* Applicable in Gailpur plant only.

- Colours in the catalogue are as accurate as printing process allows. Please check actual tile sample before making the final selection.
- Sizes mentioned in the catalogue are nominal sizes only.
- No claim will be entertained once the tiles are fixed.
- For better laying, please follow the instructions on the packaging box.
- In case it is required to lay the tiles on wall or floor in STAGGERED PATTERN, then always lay them in Overlap 20:80 ratio, as shown in VISUAL 1 instead of Brick pattern (overlap 50:50 ratio), as shown in VISUAL 2.

Please make sure to check the shade/finish with the sales agent/dealer before making the final purchase because there might be variation in actual finish and that shown in the catalogue. The company will not bear any loss in such case.



VISUAL 1



VISUAL 2

DISPLAY CENTRE

North

CHANDIGARH:
SCO-8,1st floor, Sector 7C,
Madhya Marg, Chandigarh-160019
Phone: +91-172- 4631417
Mobile: 9779021253, 9779021262

DEHRADUN:
Fortuna Tower, 1078, First Floor,
Opp. IMA Blood Bank,
Chakrata Road Dehradun - 248001
Mobile: 7755001347, 9717795202
7755001346

JAIPUR:
G-1, G-2, Aishwarya Tower,
Near Hotel Hawa Mahal, Ajmer Road
Jaipur-302005, Rajasthan
Phone - +91-141 2223425, 9799495766

LUCKNOW:
7, Tajpuria palace, Faizabad Road,
Indira Nagar, Lucknow, Uttar Pradesh
Mobile: 9717795204, 9956252777

VARANASI:
Rukmani Tower, N8/247-2K-1,
DLW, BHU Road, Newada, Sunderpur
Varanasi-221005, Uttar Pradesh
Mobile: 9794865554, 9005095500

South

BANGALORE:
Farah Icon, 119 2nd Floor,
Opp. New Pass Port Kendra, Lalbagh Road,
Bangalore-560027, Karnataka
Mobile: 9008402949, 9008016799

CHENNAI:
Old No.10, New No.46, Montieth Road Above Wait
Rose Super market
Egmore, Chennai - 600008.
Mobile: 9791178678, 9952094333

COIMBATORE:
1st Floor, No.57, Cowley Brown Road, Near Central
Library, R.S. Puram Coimbatore - 641002.
Mobile: 9629944454, 9677708080

COCHIN:
Door No. 48/557-C, MN Square
Near Gold Souk, NH By-Pass, Vyttila,
Cochin 682019, Kerala
Mobile: 9995868863, 9746473684, 7303663188

HYDERABAD:
#3 - 143, 1st Floor, Nirvana Building,
Kavuri Hills, Police Station Opp.Road, Madhapur
Hyderabad - 500081, Telangana
Mobile: 9000304996, 9000304992, 9000005383,
7680000890, 9000304997

West

MUMBAI:
B WING, 617-620, Bonanza,
Sahar Plaza Complex, 6th Floor,
M. V Road, Near Hotel Kohinoor
Continental, JB Nagar, Andheri East.
Mumbai - 400059, Maharashtra
Mobile: 8968586560, 9987789500

PUNE:
2nd Floor, Grace Platina,
Opp.Kumar Pacific Mall,
Shankar Seth Road,Pune - 411042
Mobile: 9730088497, 9730088498

Sales Representative

NORTH

GURGAON:
Mobile: 9971744115, 9717795210,
9717795205

NOIDA:
Mobile: 9717795156, 9717795200,
9717795205

DELHI & FARIDABAD:
Mobile: 9560553304, 9717795029,
9717795192

KUMAON:
Mobile: 7755001348, 7755001349,
9717795202

WESTERN UP:
Mobile: 9717795202, 8800093020,
7755001348

HARYANA:
Mobile: 8295200155, 8295200410

LUDHIANA:
Mobile: 9779021264, 9779021270,
9779021255, 9779021267

HIMANCHAL PRADESH:
Mobile: 9779027169, 9779021253

JAMMU & KASHMIR:
Mobile: 9906906622, 9086411081

EAST
ASSAM:
Mobile: 9311299711, 9903234184

BIHAR:
Mobile: 9771458963, 9892408080

JHARKHAND:
Mobile: 9934011406, 8882918981

ORISSA:
Mobile: 9937185338, 9937285865,
8882918983

WEST BENGAL / KOLKATA:
Mobile: 9007011022, 9007011028,
9007062814

CENTRAL
CHHATTISGARH:
Mobile: 9981528088

RAIPUR:
Mobile: 9758598467, 9981528088

BILASPUR:
Mobile: 7898028779, 9981528088

BHOPAL:
Mobile: 9981528092

INDORE:
Mobile: 9630025576, 9981528089

WEST
AURANGABAD:
Mobile: 8600992620, 9730088497

GOA:
Mobile: 9665046116, 9730088497,
7028018708

NASIK:
Mobile: 8600992620, 9730088497,
7028030538

AHMEDABAD:
Mobile: 9998804440, 8511581725

NAGPUR:
Mobile: 9987538689, 9730088497

SOUTH
ANDHRA PRADESH:
Mobile: 9000300790

VIJAYWADA:
Mobile: 7680046467, 9000300790



AUGUST - 2022

Toll Free No. : 1800 309 309 | Email : info@kajariaeternity.com | For exports : global@kajariaeternity.com
Website : www.kajariaeternity.com