

NITCO

TILES MARBLE MOSAICO

Artisanal Collection

PORCELAIN MOSAICO

Introduction

Welcome to the future of exquisite design and unparalleled sophistication. Nitco, a name synonymous with innovation and elegance in the world of tiles and surfaces, proudly presents its latest marvel: Press Porcelain Mosaics.

The Press Porcelain Mosaics range captures the essence of opulence and ingenuity, crafted to adorn spaces with unparalleled splendor.

As you leaf through the pages of this catalogue, you'll embark on a visual journey that showcases the fusion of traditional mosaic art with cutting-edge technology, resulting in a symphony of patterns, textures, and colors that captivate the senses.

Index

Swimming Pool Collection	04-35
Penny Circle	36-47
Honeycomb	48-53
Stackbone	54-55
Brickbone	56-59
Herringbone	60-61
Lantern	62
Octa-dot	63
Long Honeycomb	64-65





Swimming Pool Collection

Cloudy Series (48X48 mm)

D. Blue



M. Green



M. Blue



L. Blue



Solid Series

(48X48 mm)



L. Blue Blend

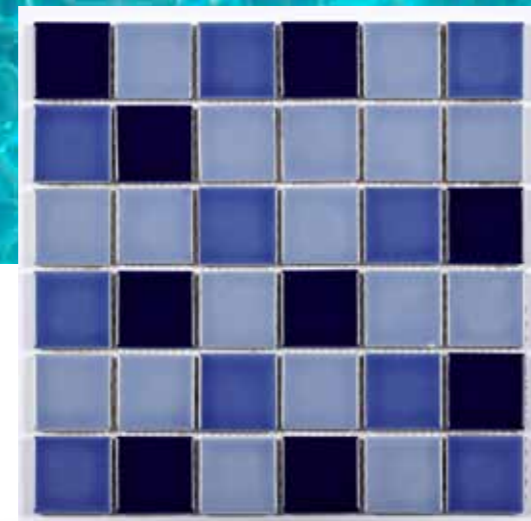

M. Blue Blend

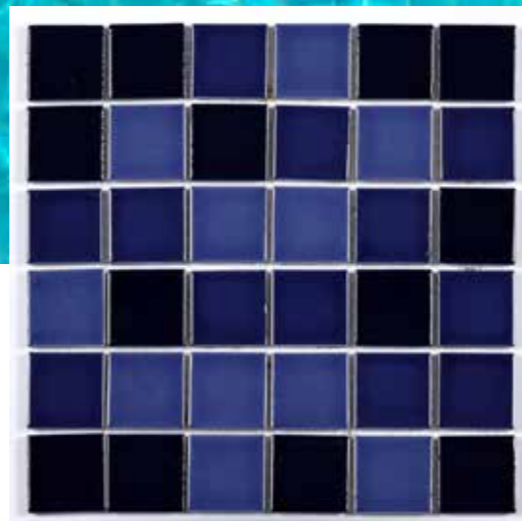

D. Blue Blend

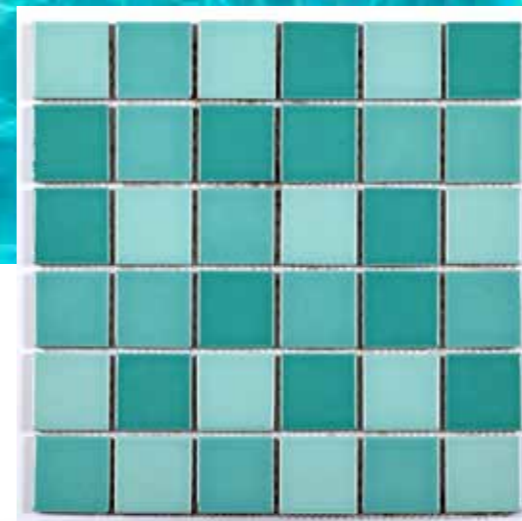

L. Green Blend

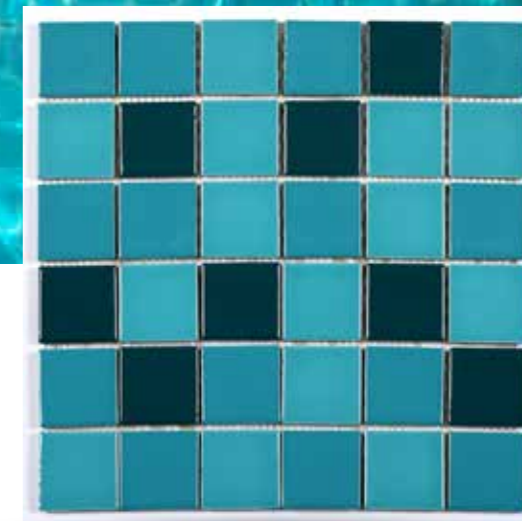

D. Green Blend

Frizzle Series (48X48 mm)

L. Blue



M. Blue

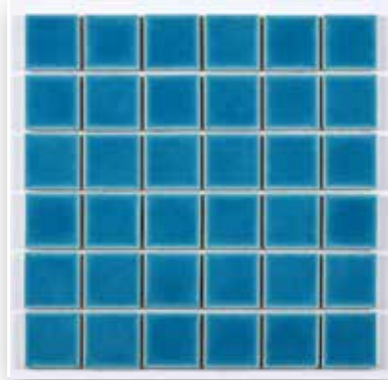

D. Blue

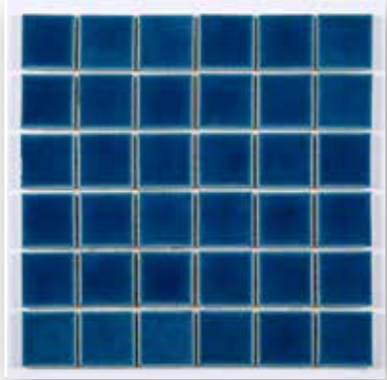

SD. Blue

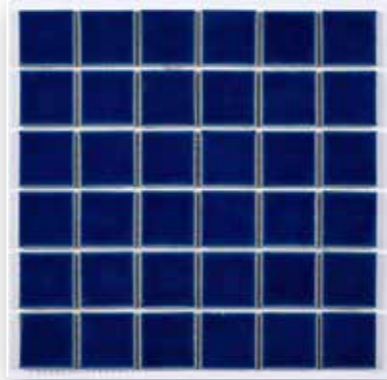

Green Checker



*L. & D. Green**

Blue Checker

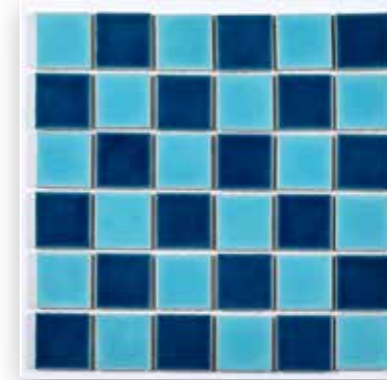

*L. & D. Blue**

L. Green

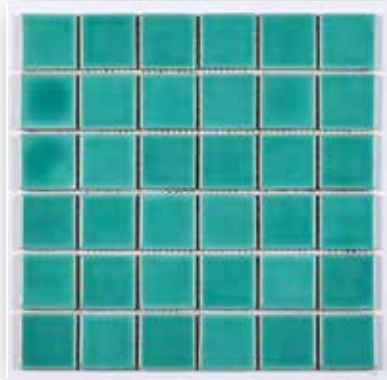

M. Green



D. Green

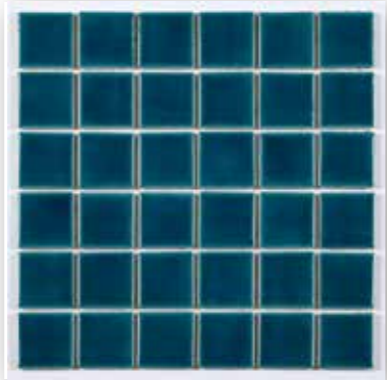

SD. Green



Green & Blue Checker

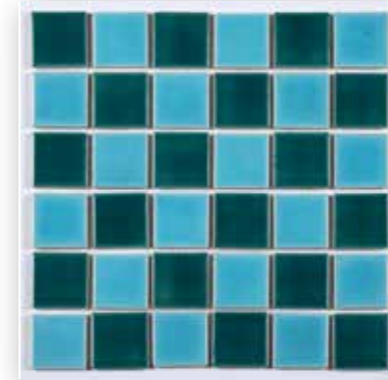

*L. Blue & M. Green**

Blue Blend

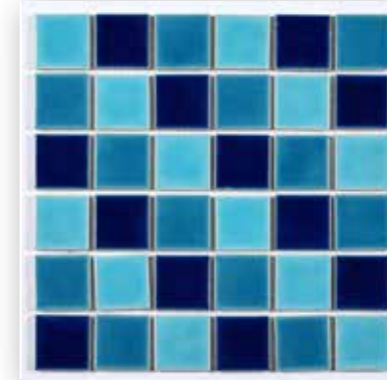

*L., M. & SD. Blue***

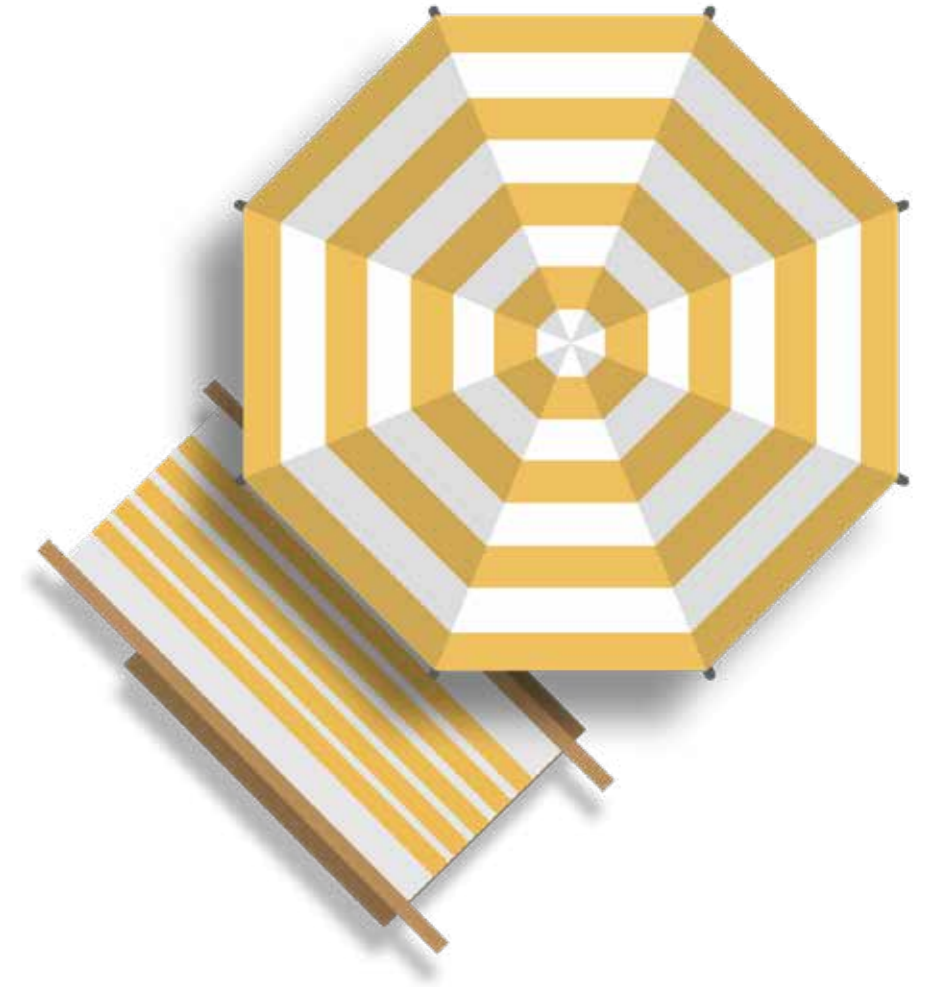

** Checkers combinations are also available in blend (Random placed pixels)
**Blend will also have colour pixels placed randomly and shall not follow a fixed pattern*

Frizzle Effect

Frizzle brings a premium Crackle effect to the surface



These are special tiles made for swimming pool to give it a shimmery effect, which also has zero porosity that leads to no fungus and scaling. The cracks are part of the design and enhance the look of the pool. They are made by applying reactive glazes to the tile surface.

The most prominent benefit of using our frizzle effect tiles in the swimming pool is their durability and low maintenance requirements. The glaze on these tiles protects them from fading over time due to sunlight exposure and chemical effects like chlorine or salt water. Additionally, cracks are less likely to form on these tiles since they have an extra layer of glazing from the manufacturing process which helps reduce wear and tear over time.



Frizzle Exclusive

Being the pioneers for surface innovations we at NITCO have created unique mosaic patterns to make your pool look one of a kind.

Sapphire Springs

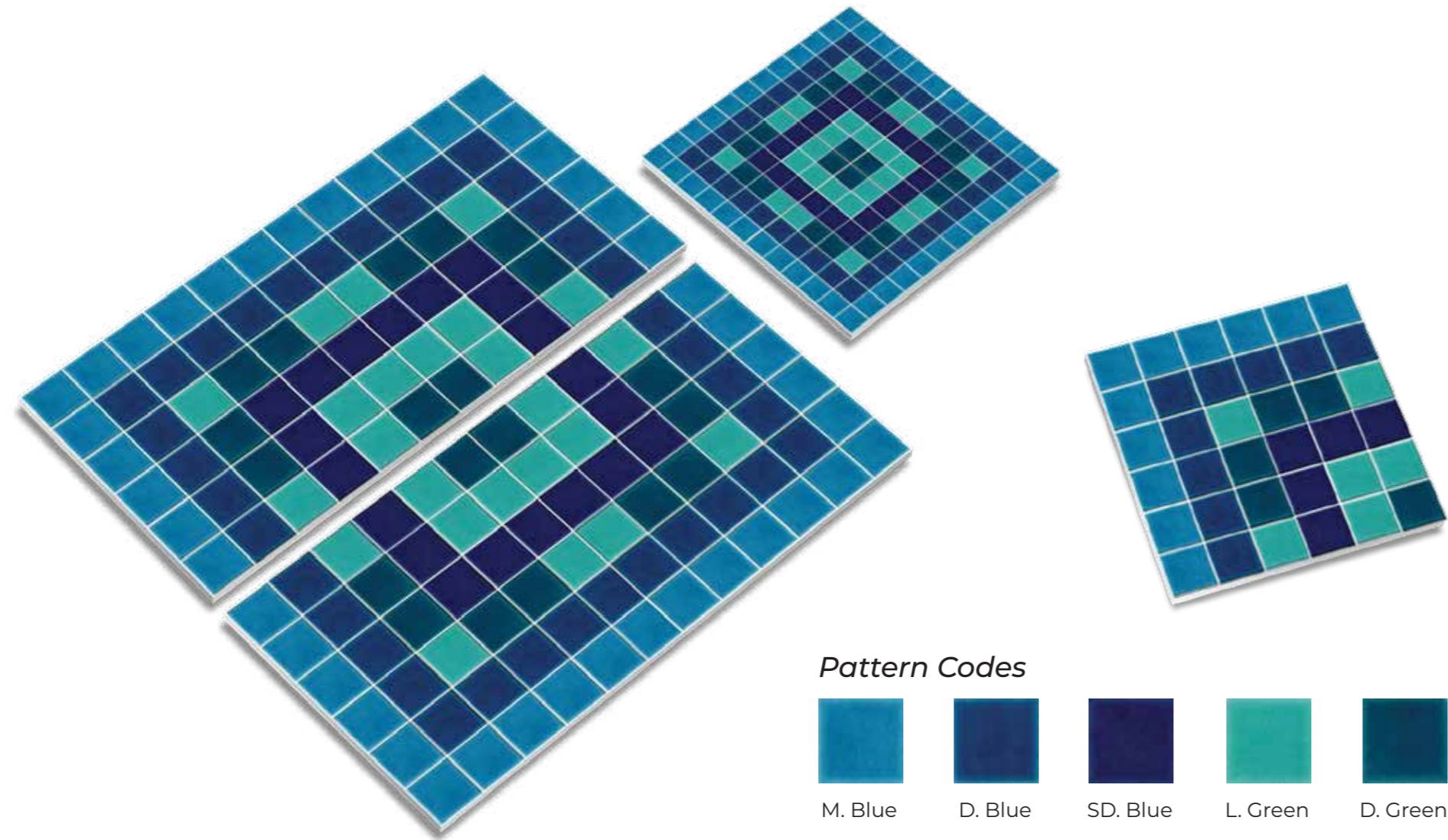

Island Breeze

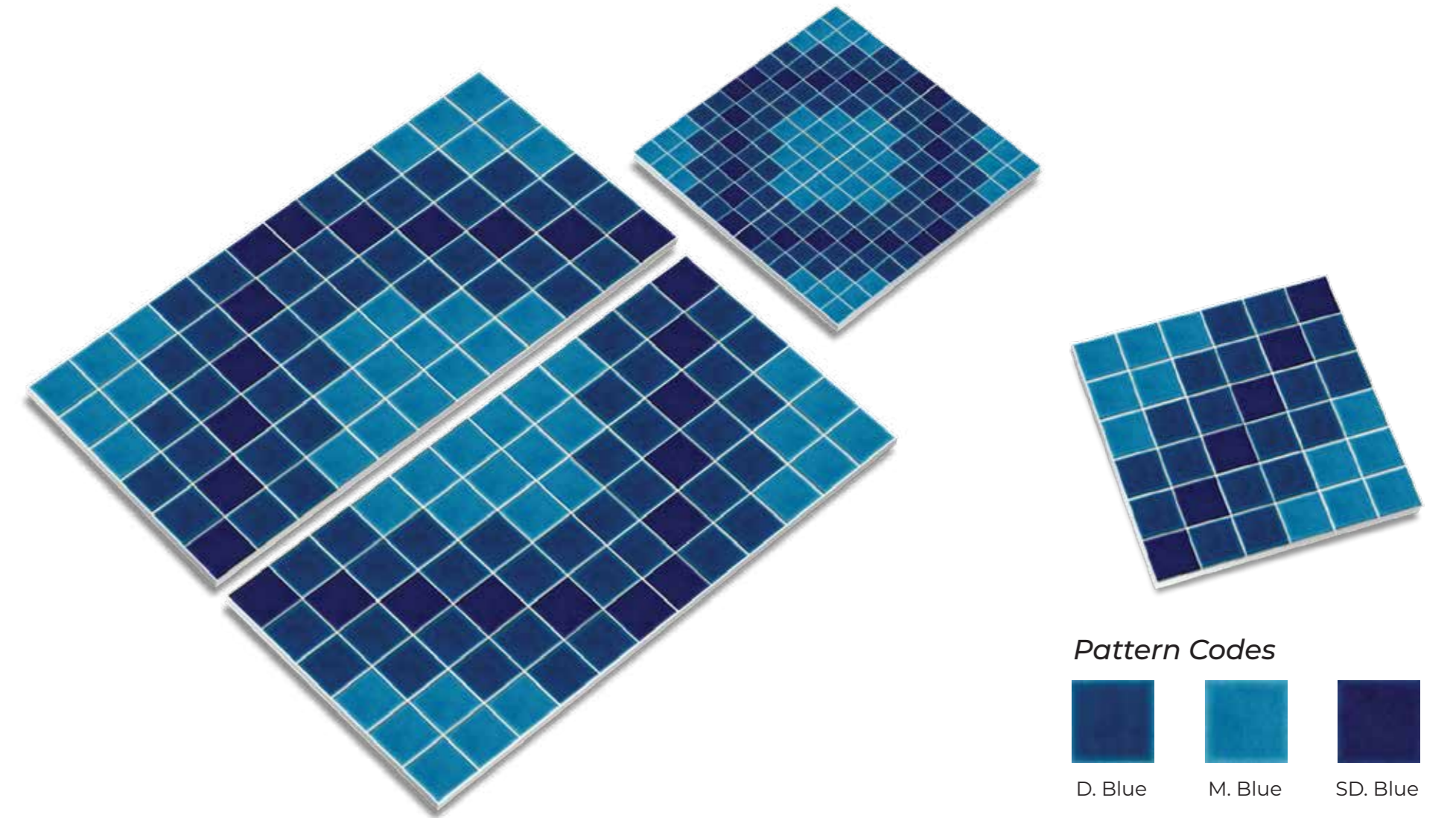



Bahamas Blue

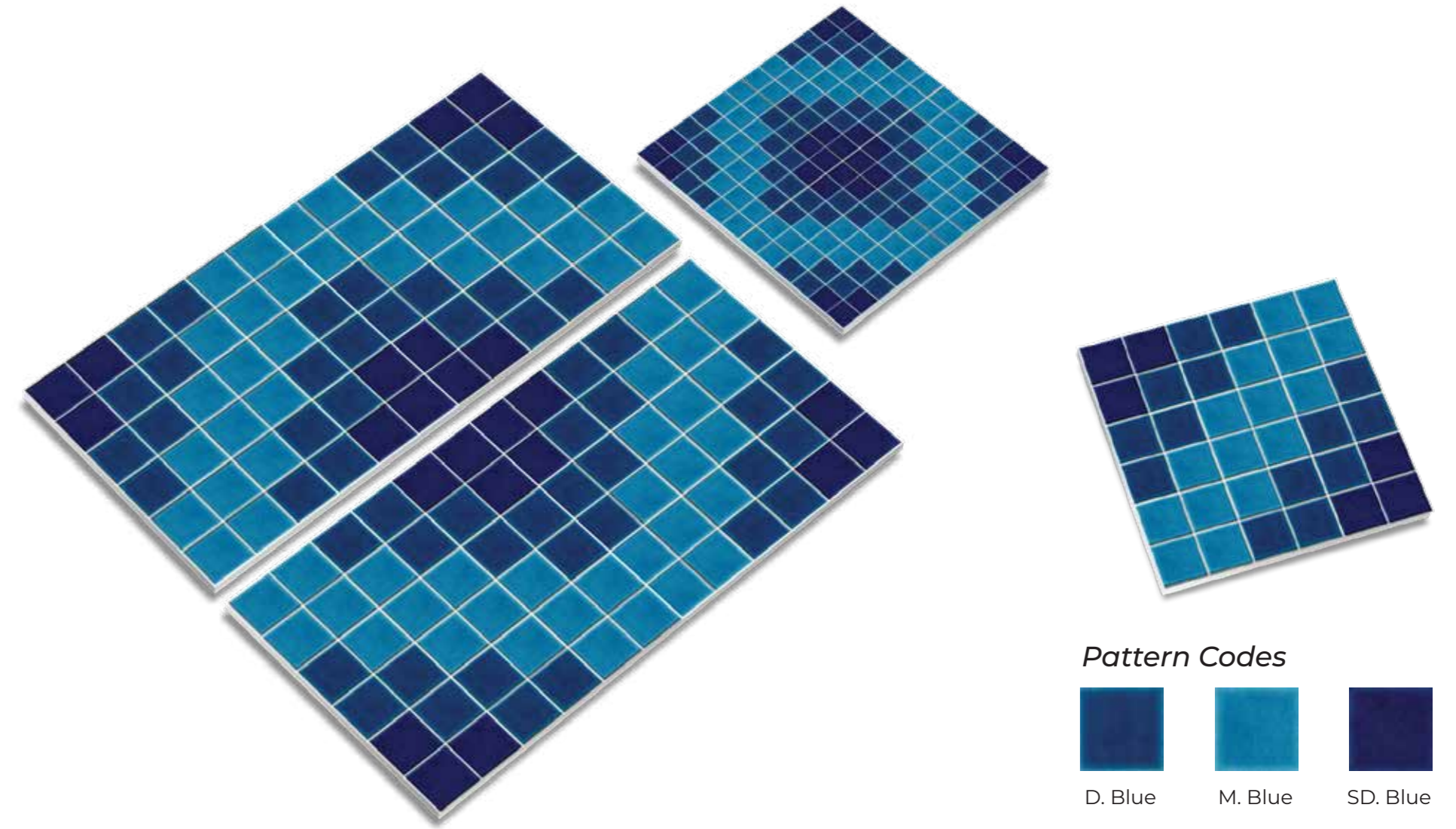

Pattern Codes



D. Blue



M. Blue



SD. Blue

Bahamas Green

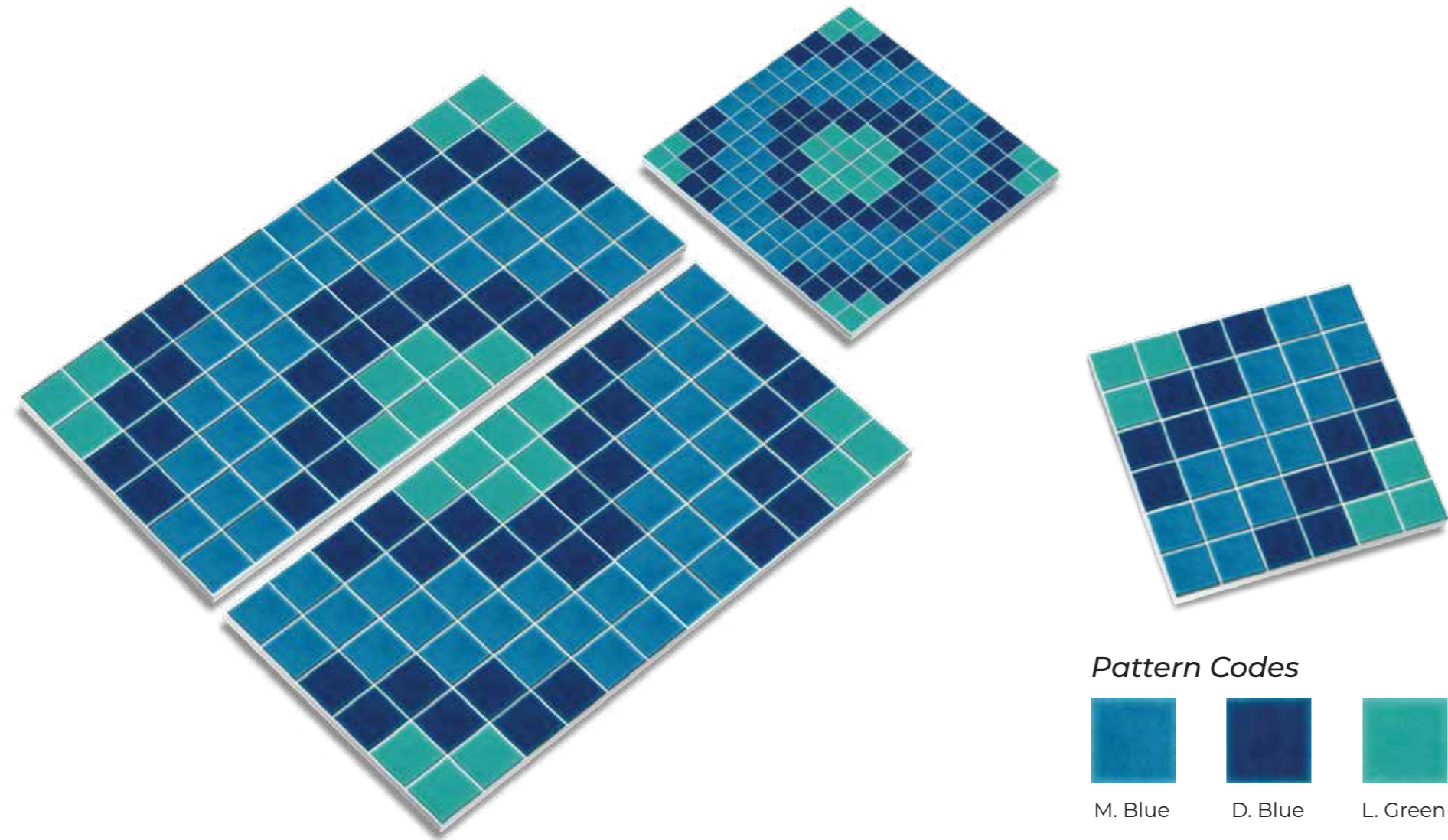

Pattern Codes



M. Blue



D. Blue



L. Green

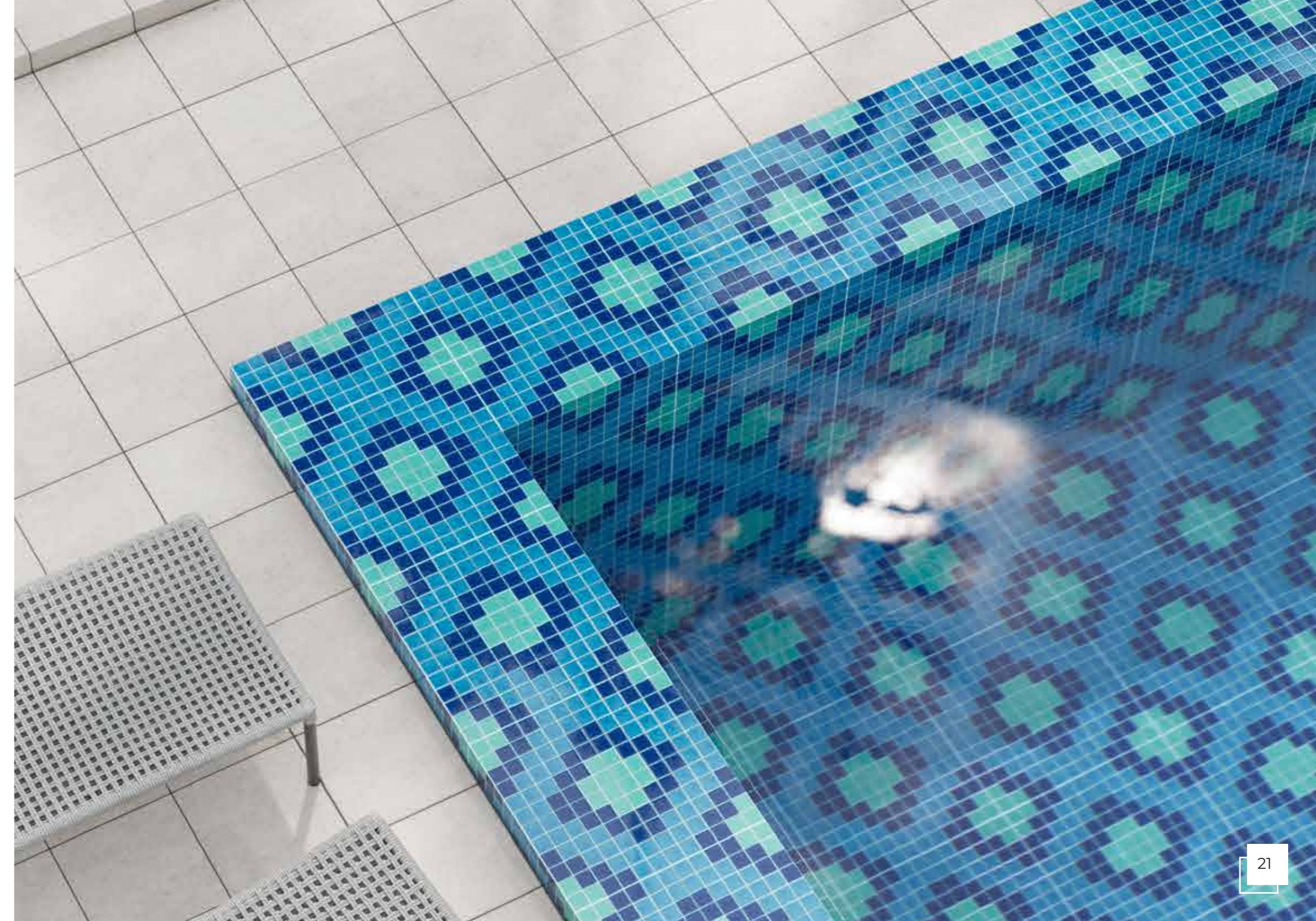

Oasis Blue

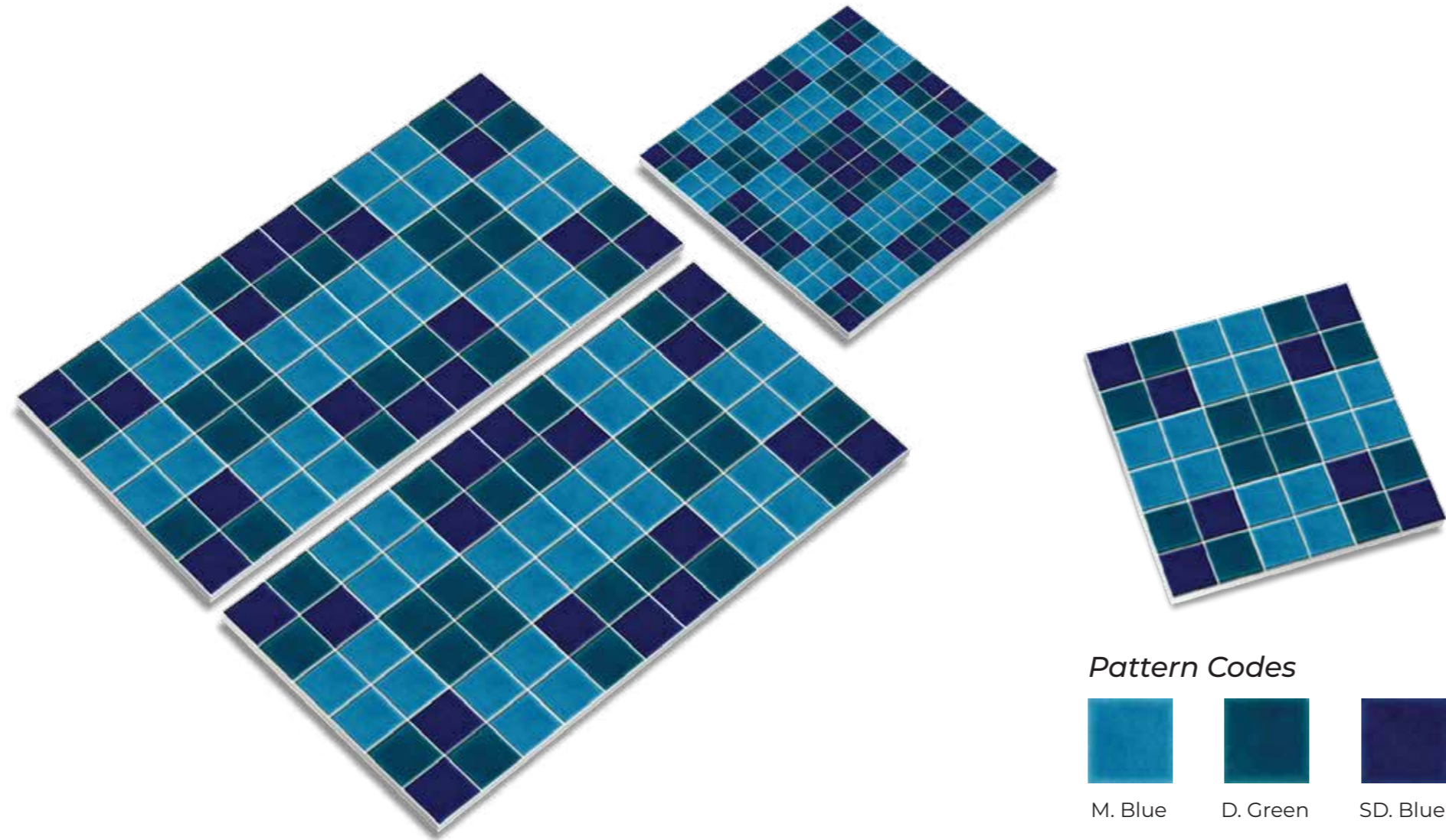

Emerald Coast

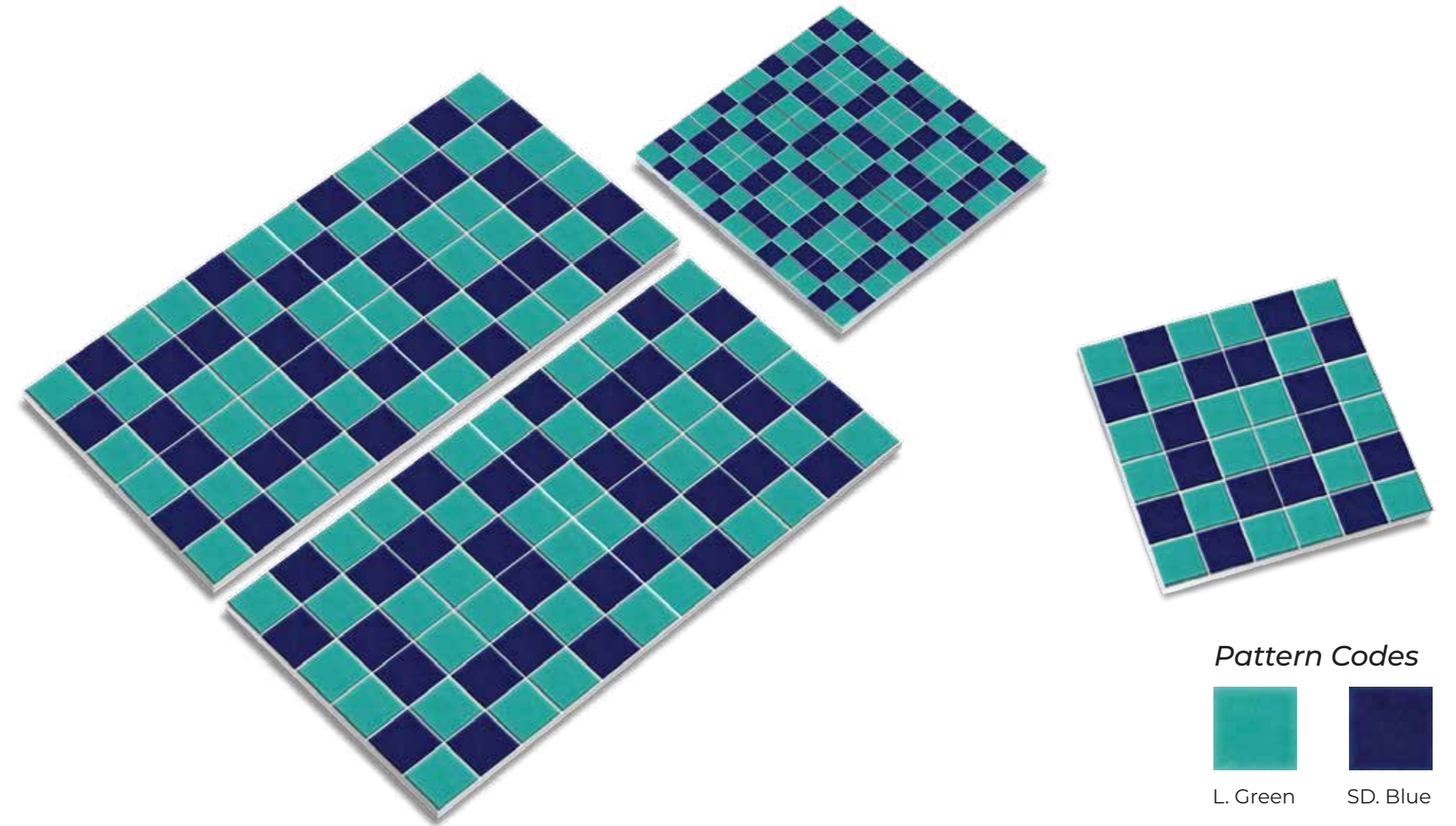

Caribbean Blue

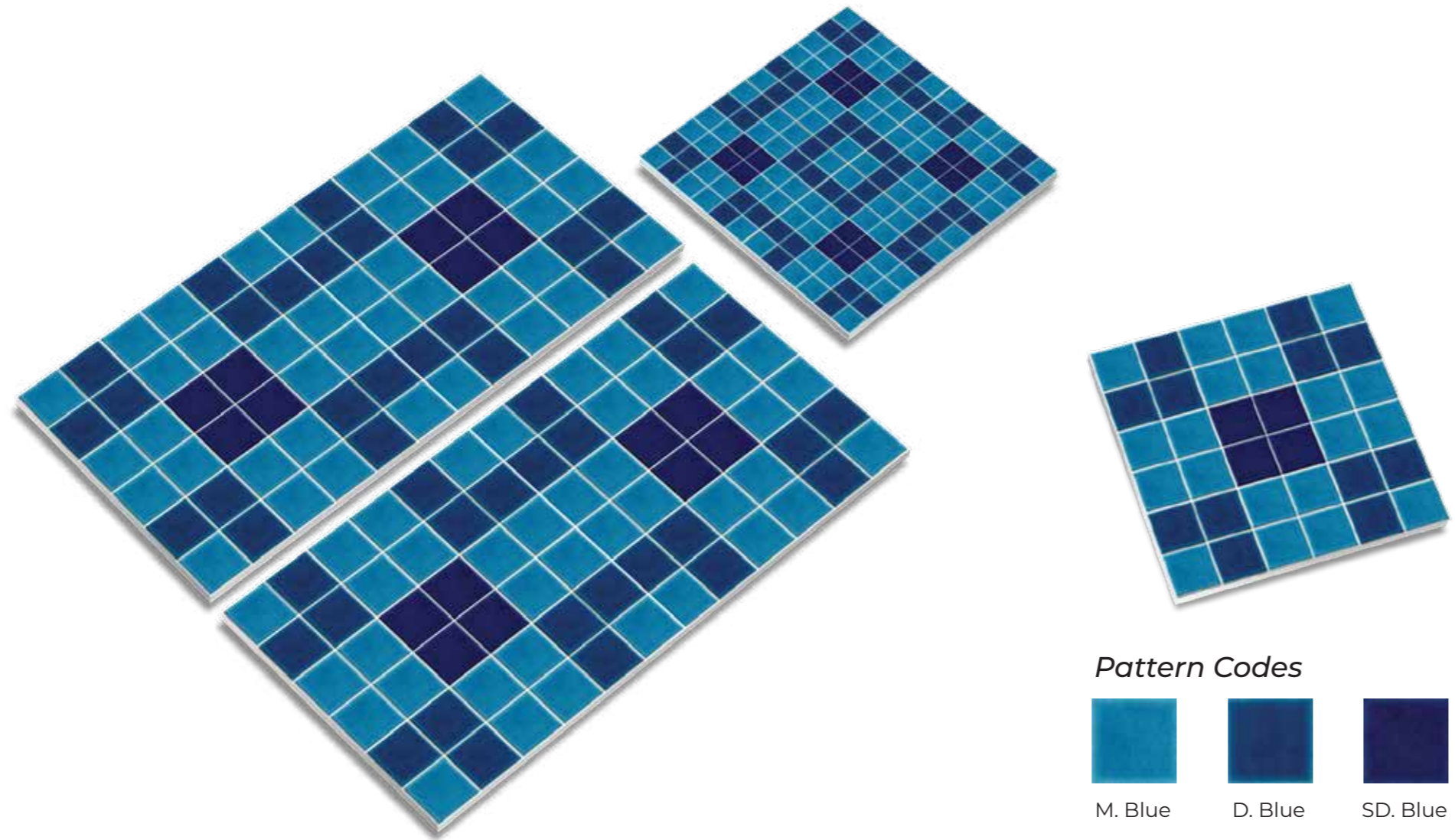



Caribbean Green

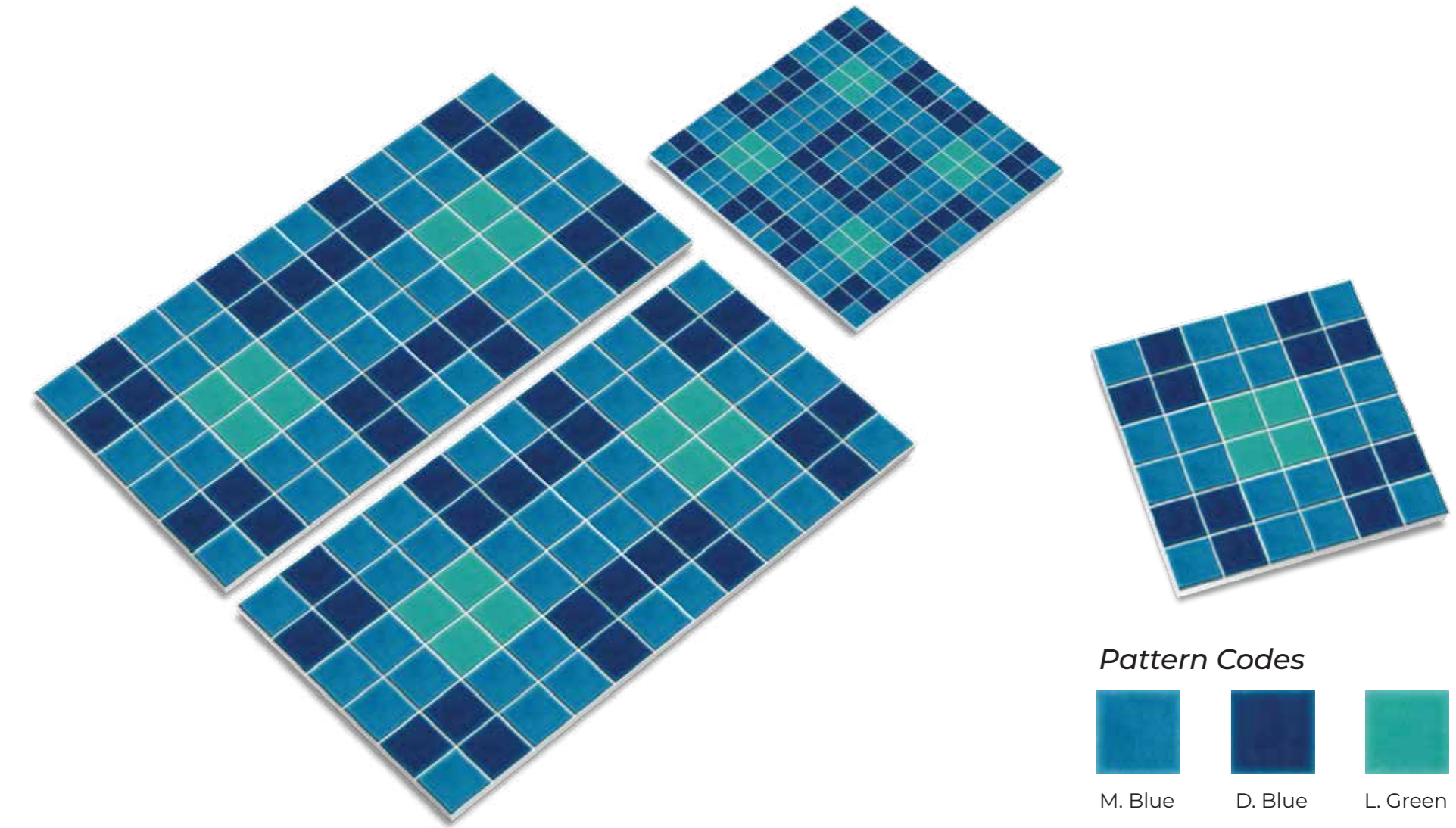

Pattern Codes



M. Blue



D. Blue



L. Green

Aquatic Escape

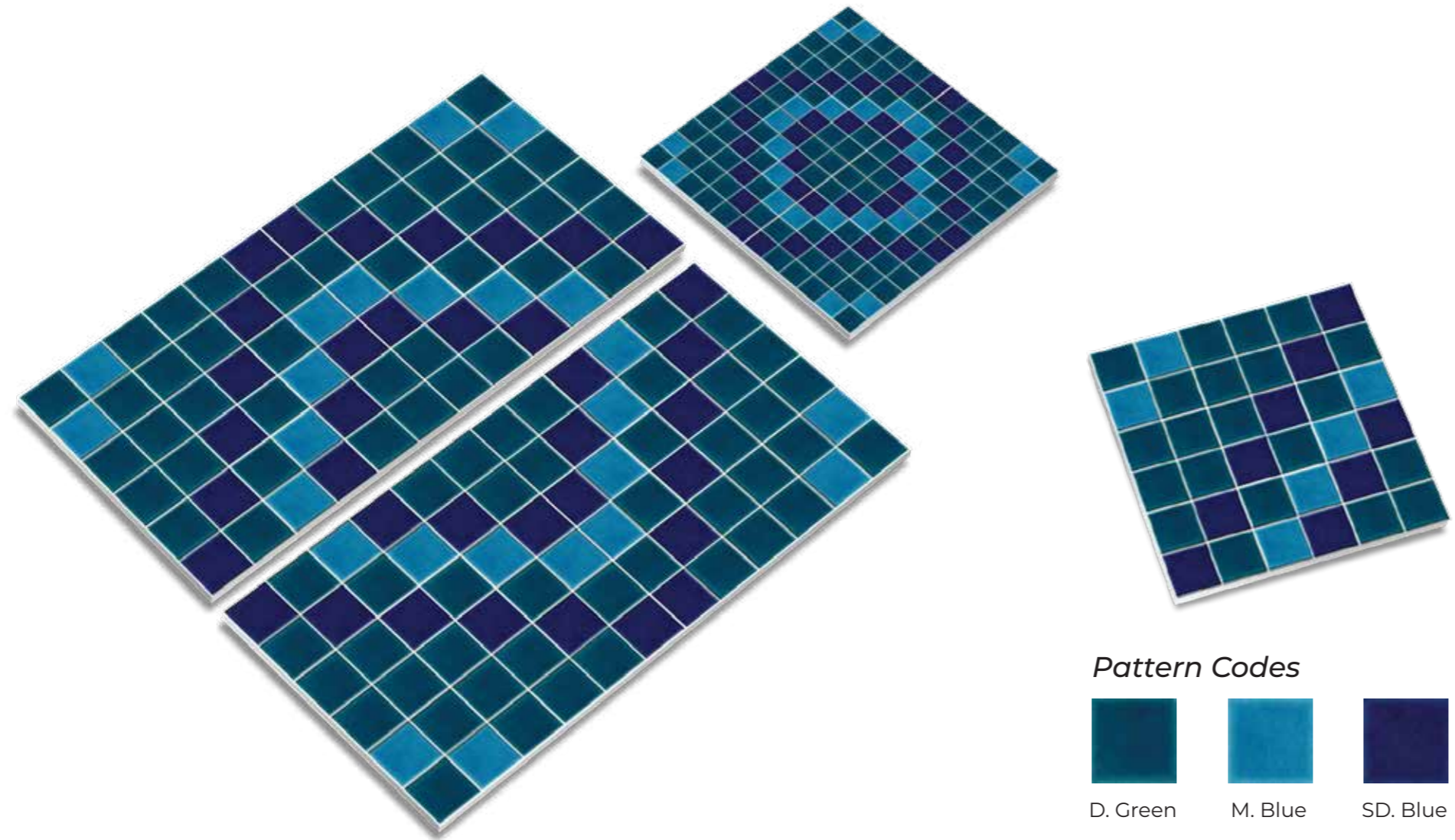



Blue Wave

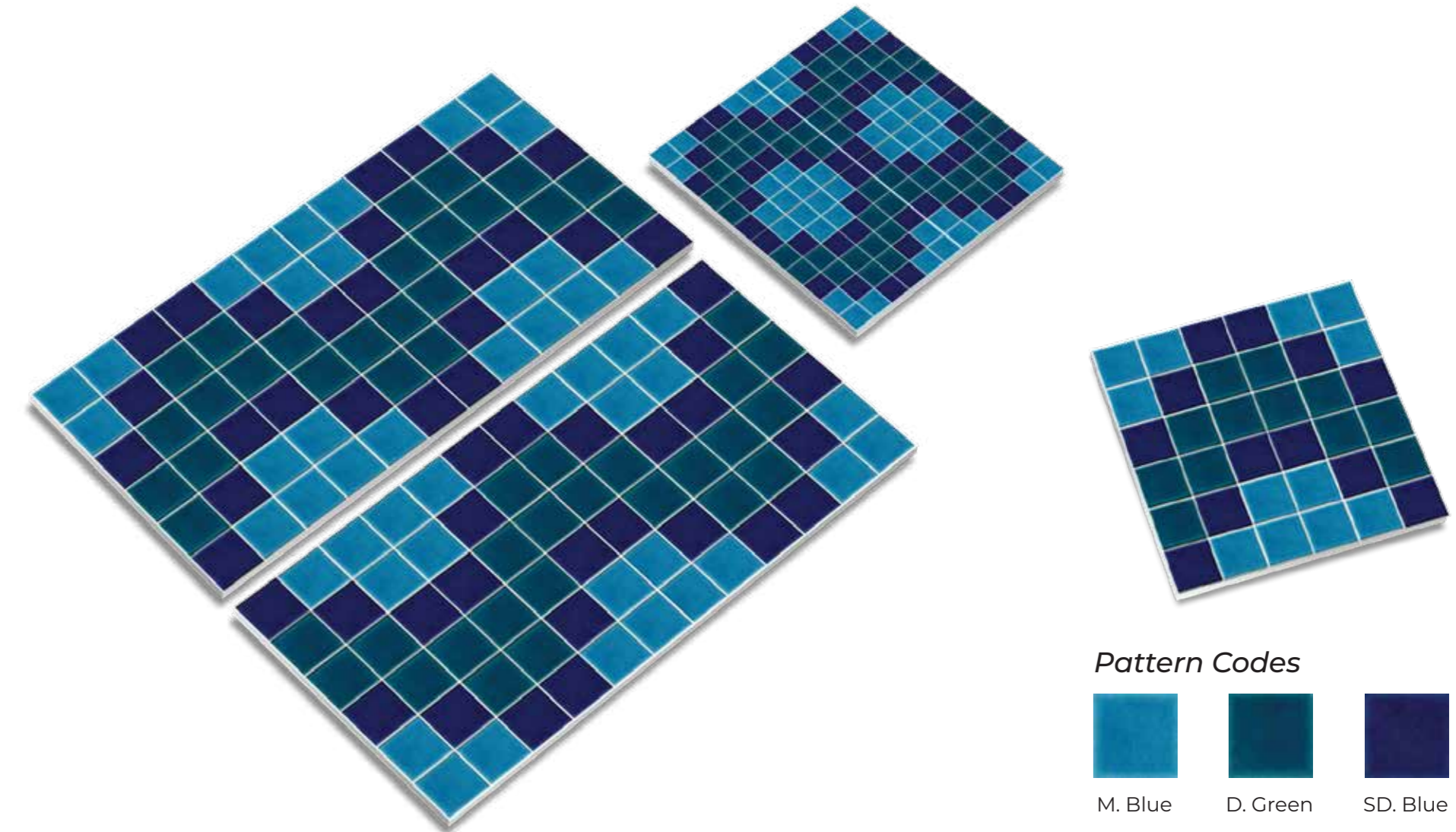

Sunset Springs

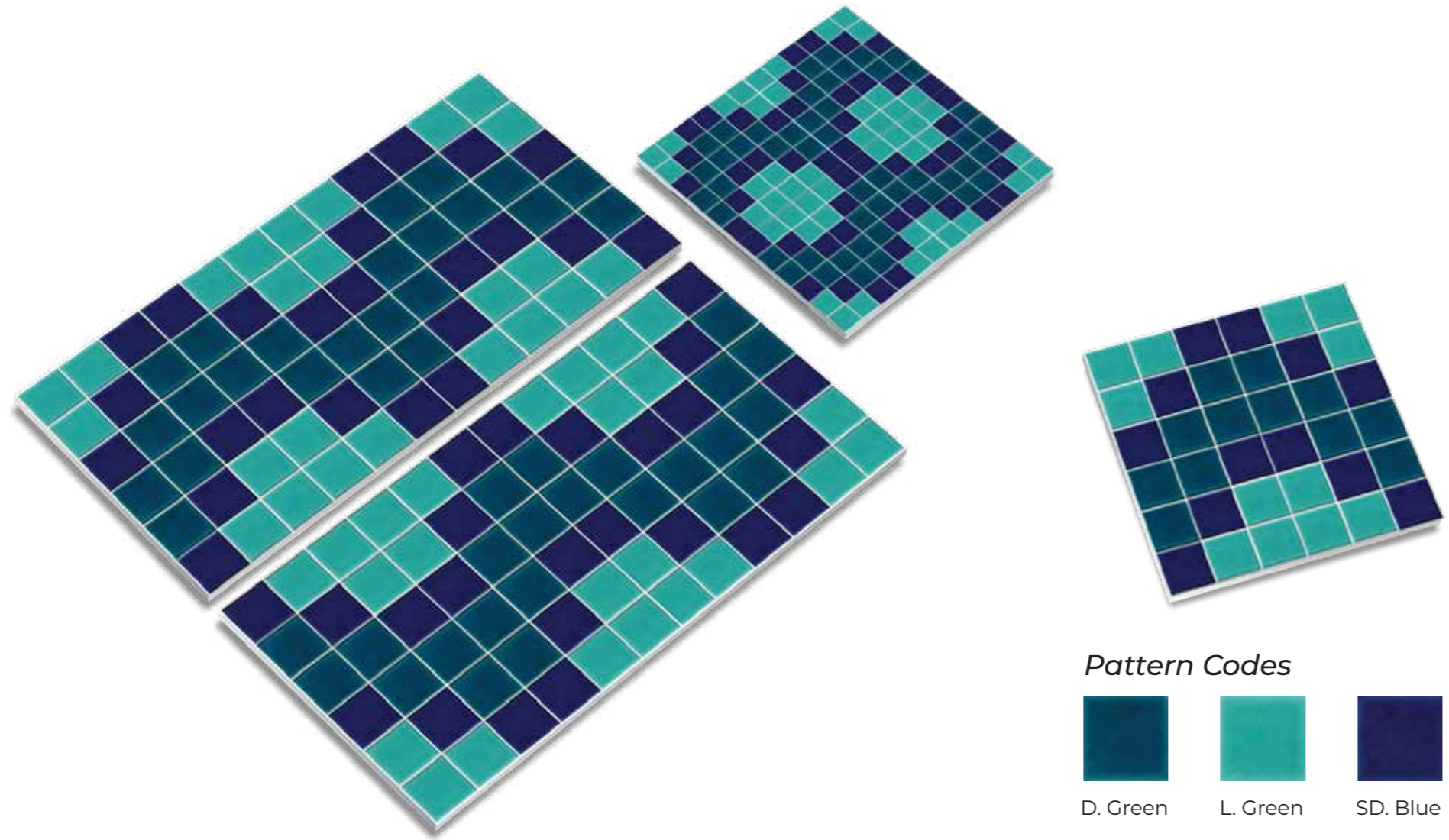

Pattern Codes

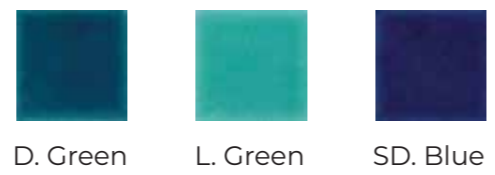

Infinity Edge

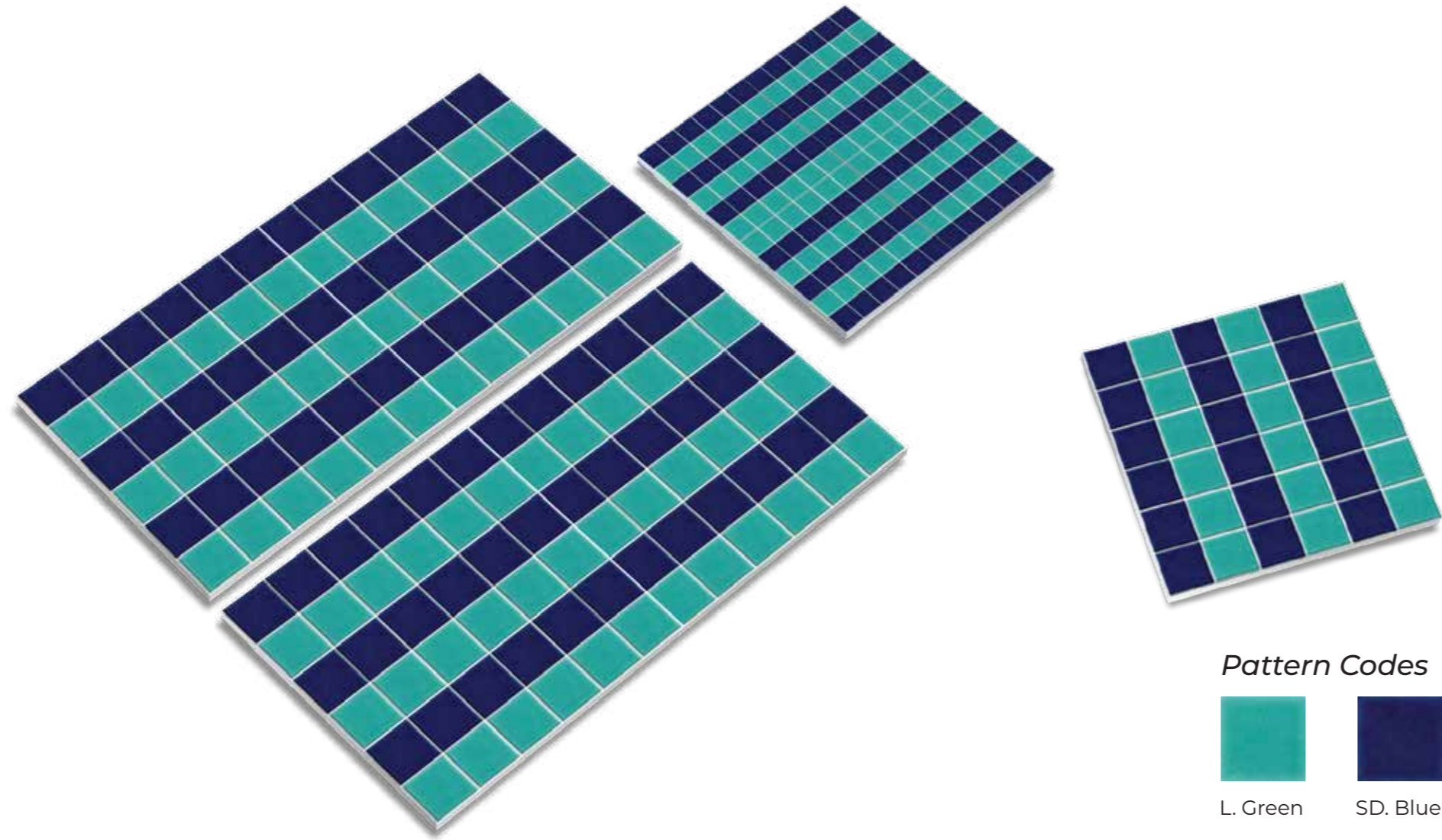

Paradise Bay

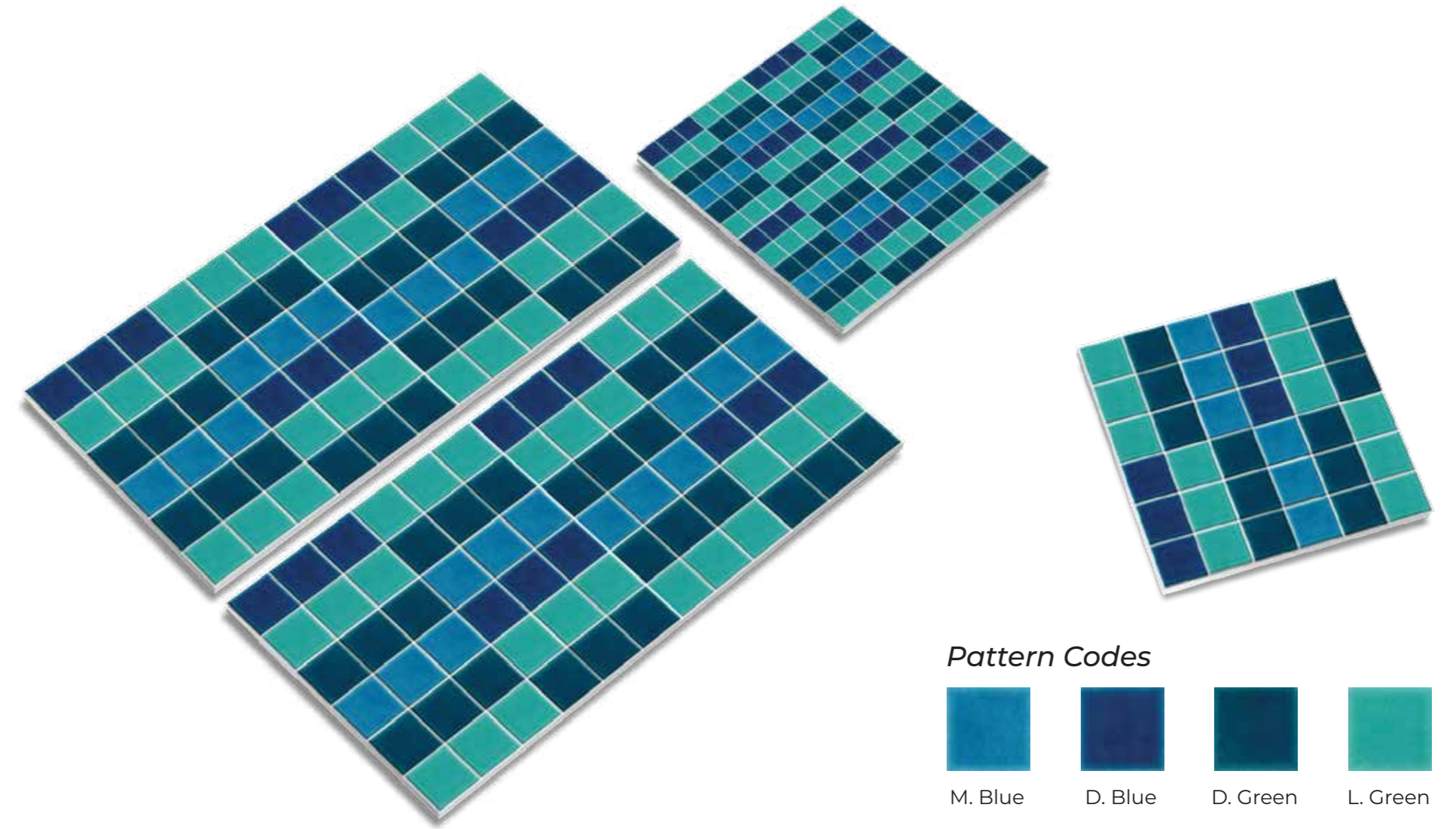

Penny Circle 19



Skirted Collection *(19 mm)*

Lavender



Opaline



Tapioca



Willow

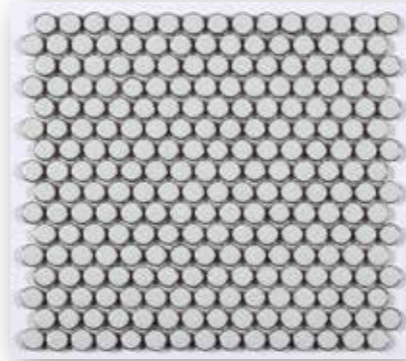

Cerulean



Cloudy



Cinder

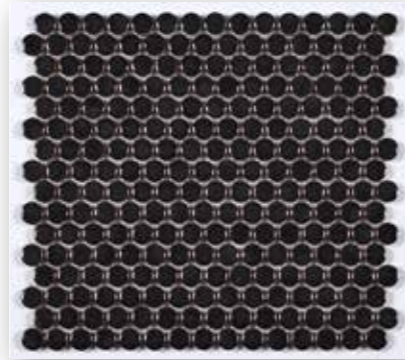

Indigo

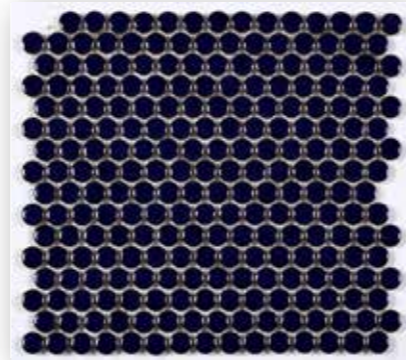

Vert

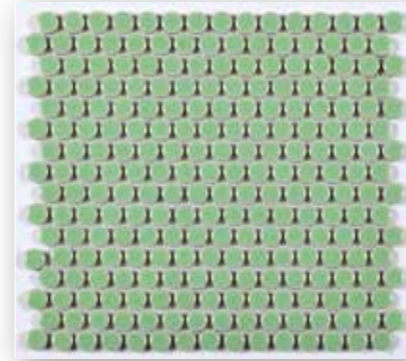

Coral



Solid Collection (19 mm)

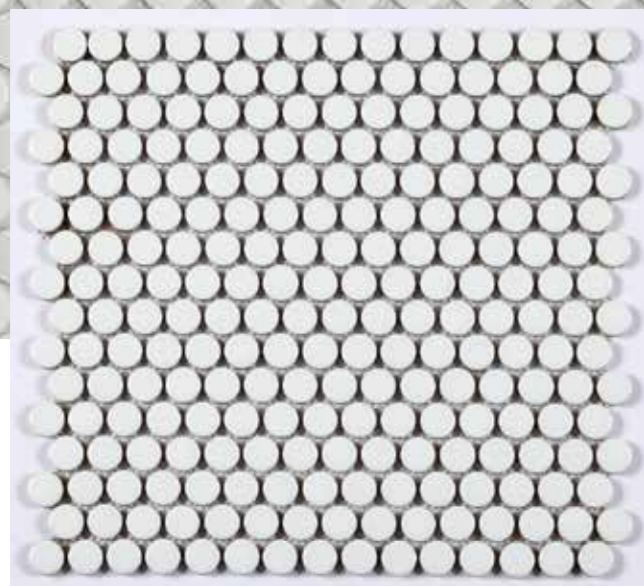

White

G

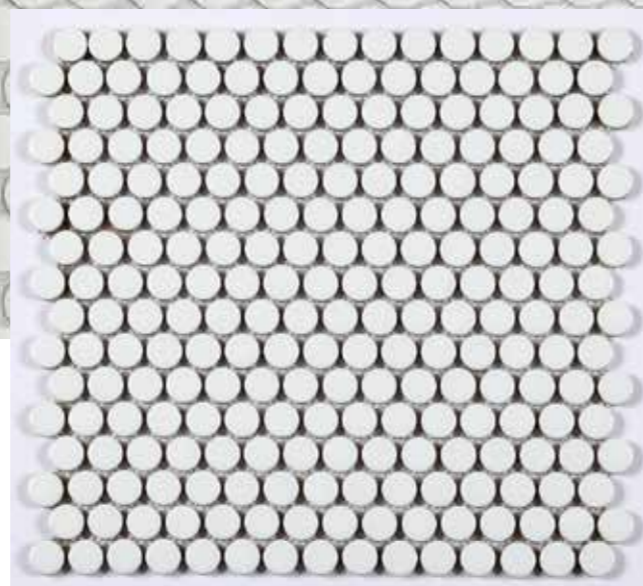

White

M

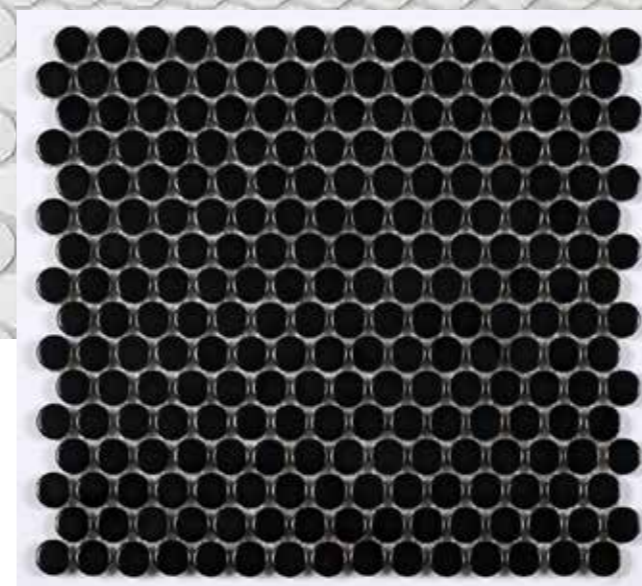

Black

G

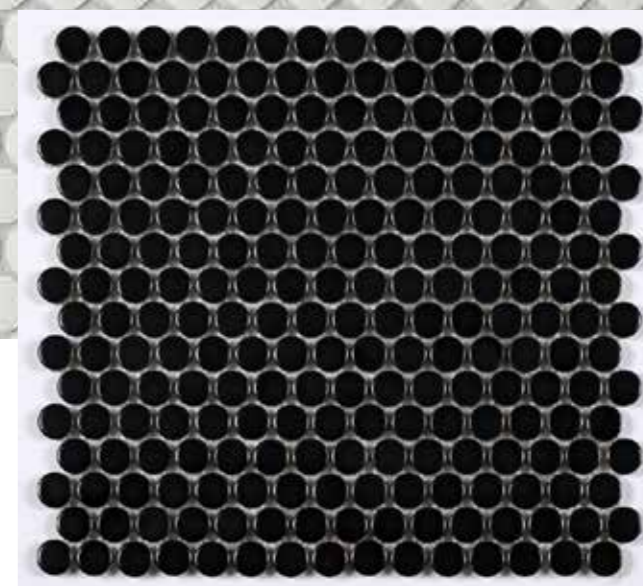

Black

M

A wall of blue penny tiles with a tray of perfume bottles in the foreground.

Penny Circles 30

Skirted Collection *(30 mm)*

Midnight Blue



Vanilla White



Solid Collection *(30 mm)*

Gris



White



Firma



FUSION Collection

(30 mm)

Turquoise

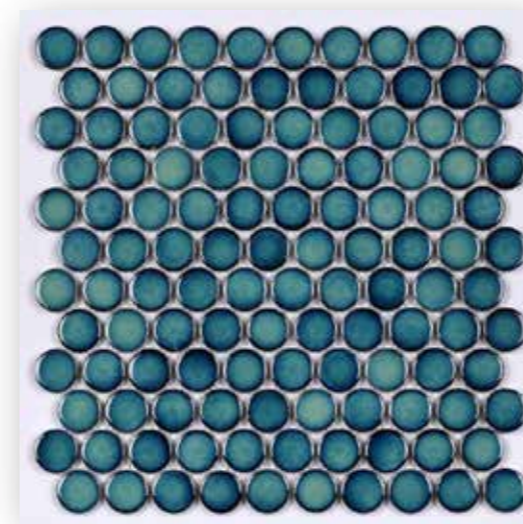

G

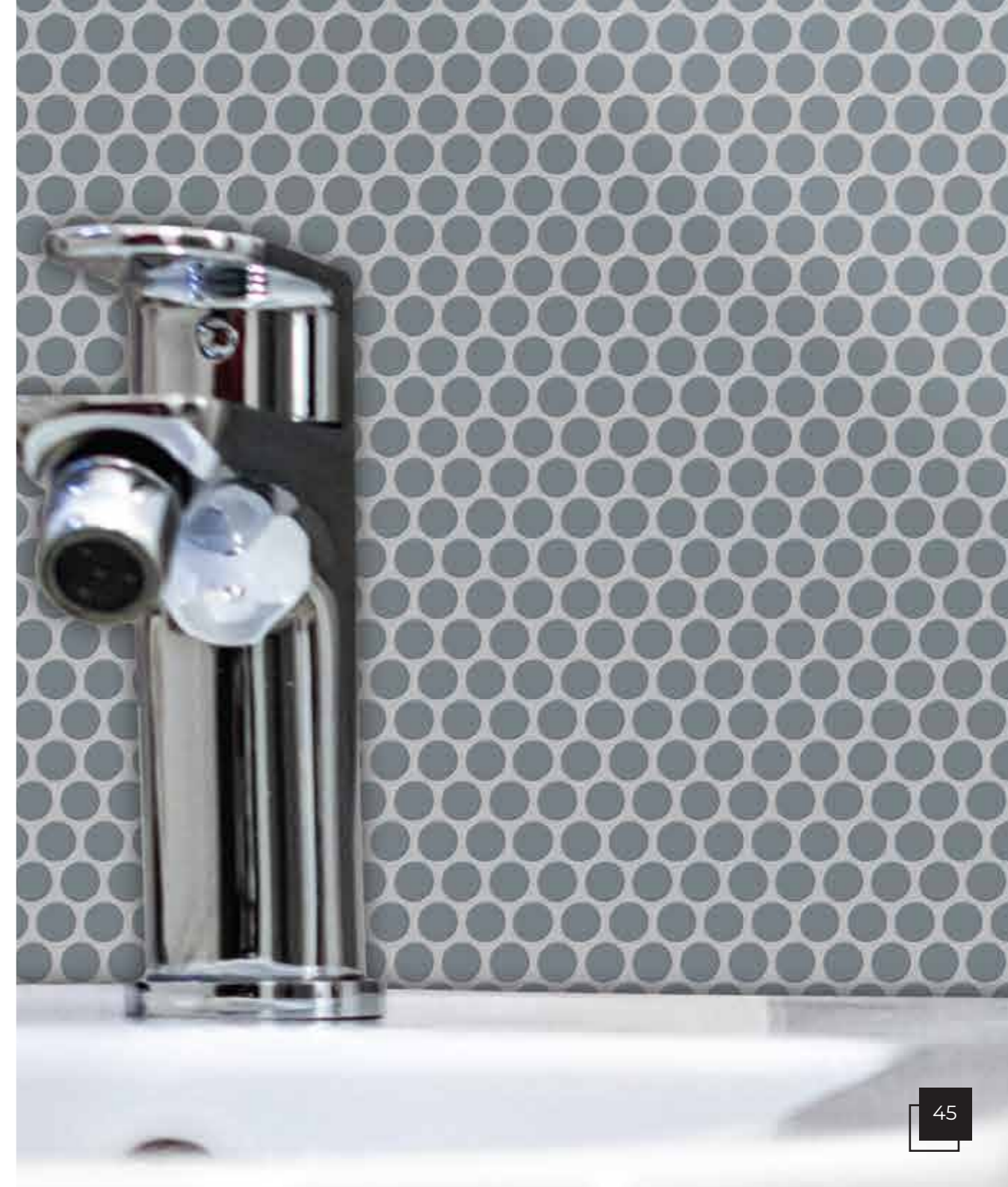

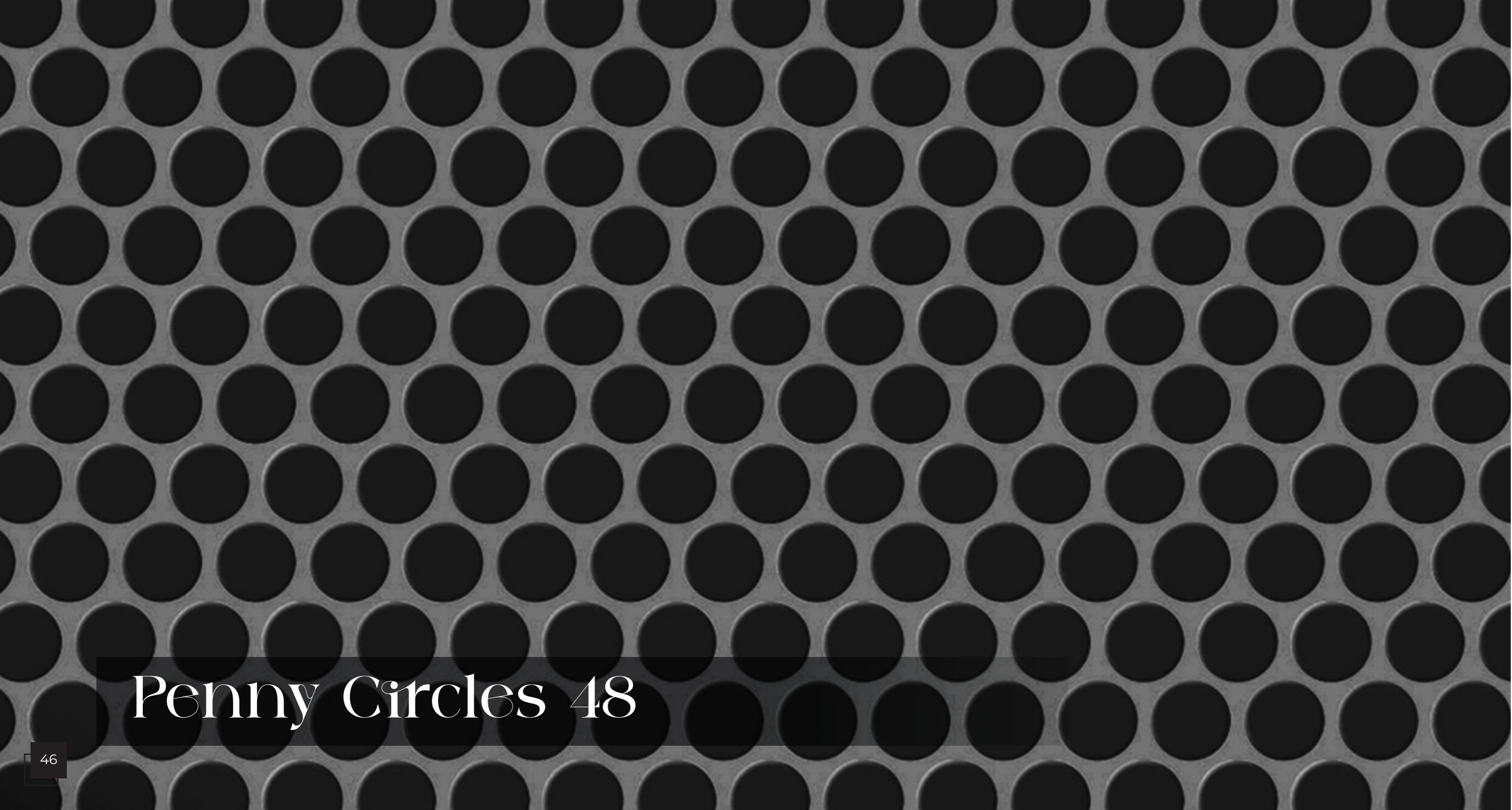

Penny Circles 48

Solid Collection *(48 mm)*

Black

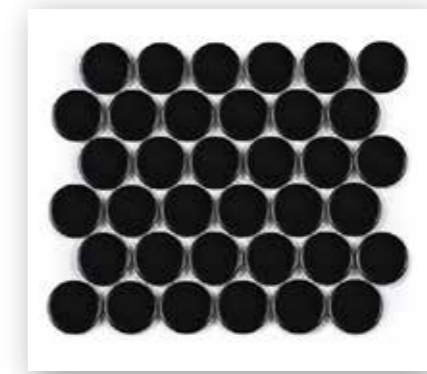

M

White



M

FUSION *(48 mm)*

Turquoise

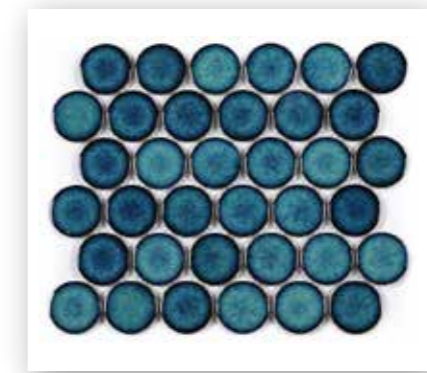

G

Honeycomb 51X59



White

M

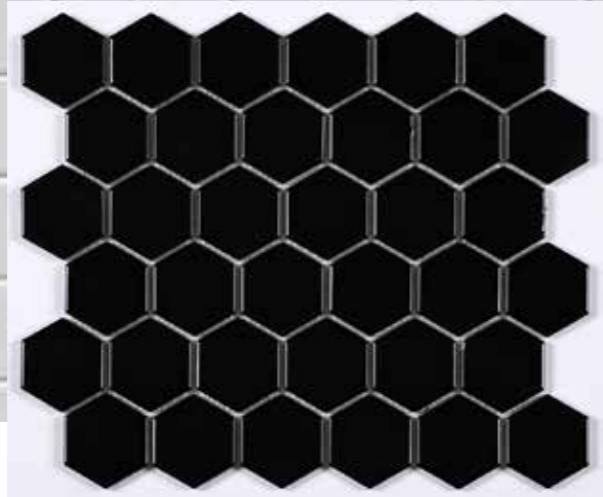

Black

M

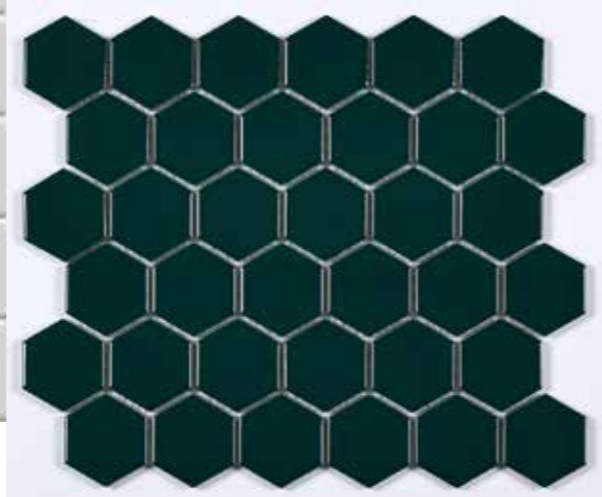

Green

G

Solid Collection (51x59 mm)

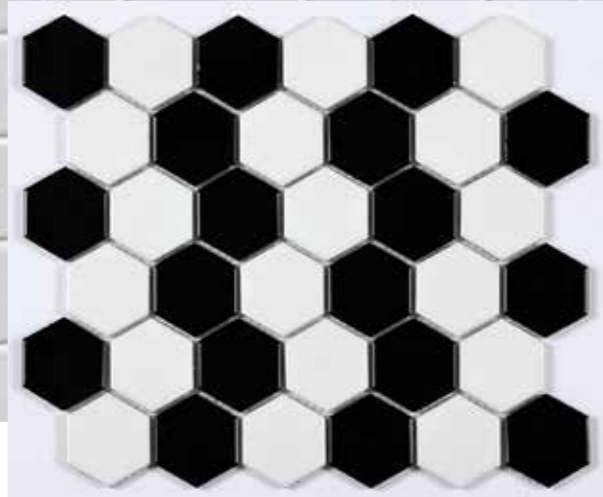

White & Black

M

Blend Collection (51x59 mm)



Honeycomb 23X25

Skirted Collection (23x25 mm)

Lavender

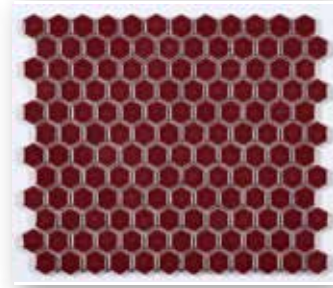

Opaline

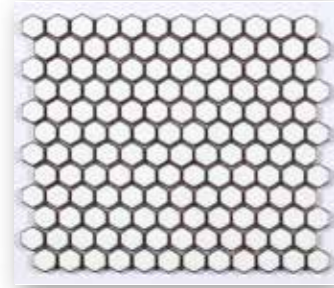

Tapioca



Willow

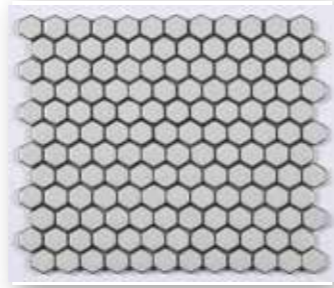

Vert

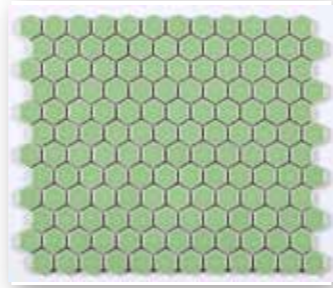

Cerulean



Cloudy



Cinder



Indigo

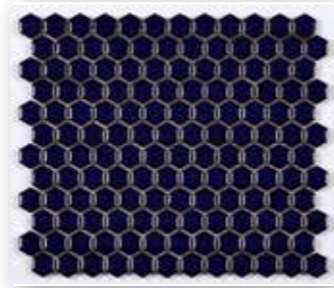

Coral



Solid Collection (23x25 mm)

White



G

White



M

Black



G

Black



M





Stackbone

Fusion Collection *(12x93 mm)*

Turquoise



G

Midnight Blue



G

Green



G

Azure blue



G

Grey



G

Blue

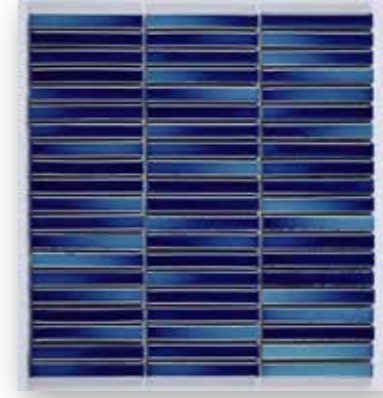

G

Pink



G

Brown



M

Brickbone



Solid Collection

Black



(45x145 mm) **M**

White



(45x145 mm) **M**

Black

Bevelled



(45x95 mm) **G**

Black

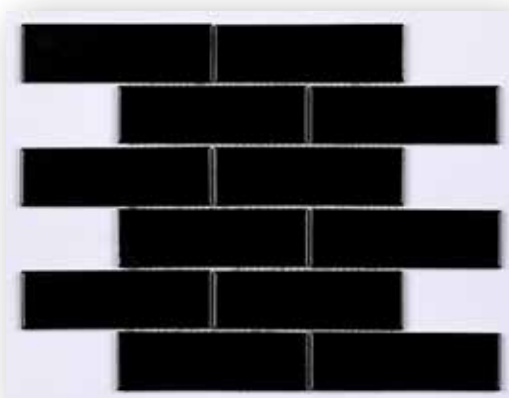

(45x145 mm) **G**

White



(45x145 mm) **G**

White

Bevelled



(45x95 mm) **G**

FUSION Collection

Green

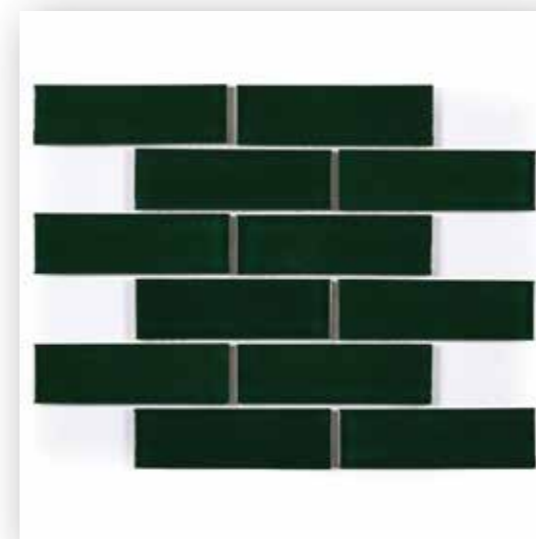

(45x145 mm) **G**

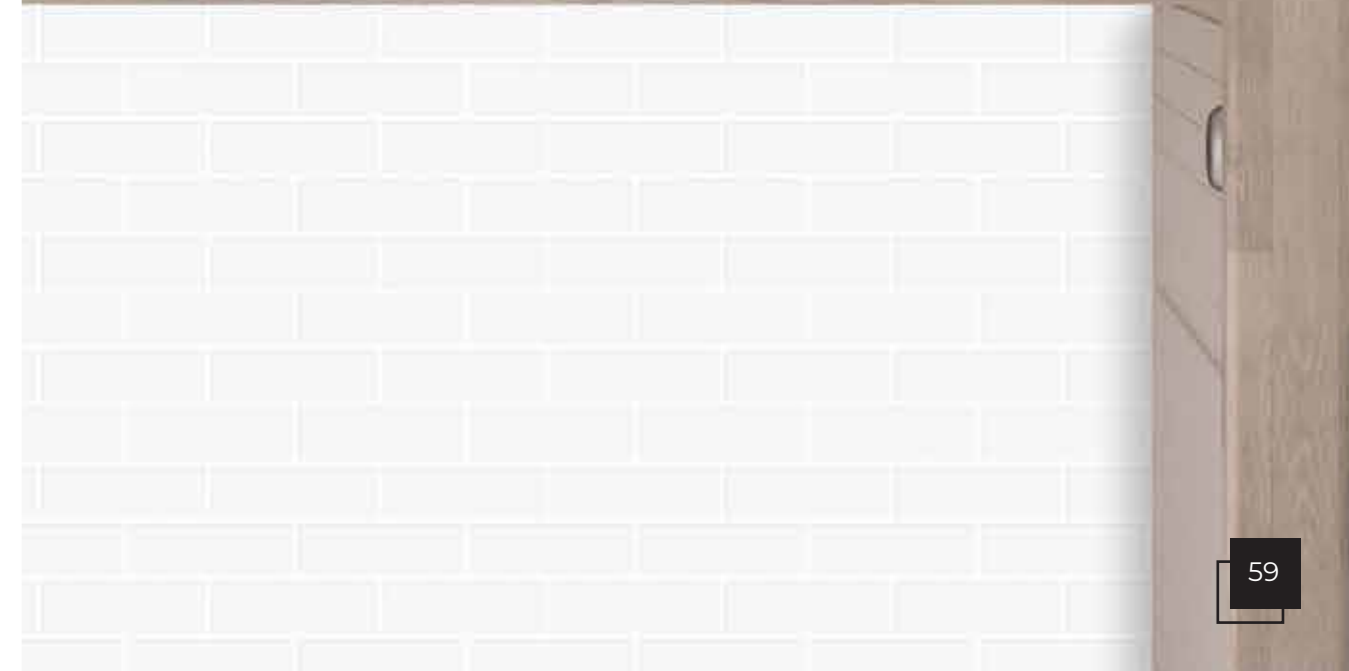

Herringbone



Turquoise **G**

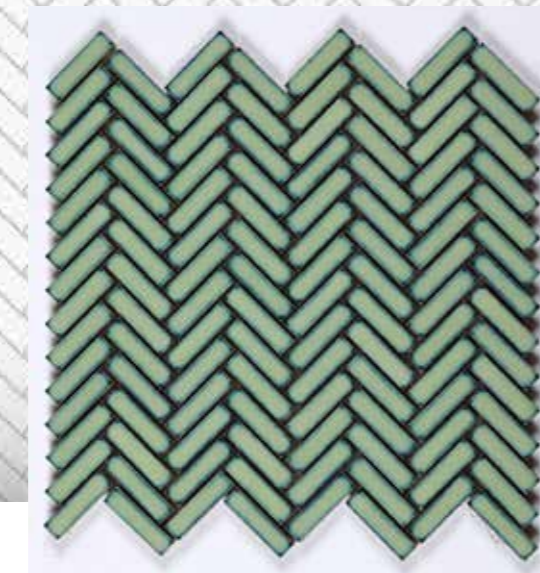

Green **G**



Midnight Blue **G**

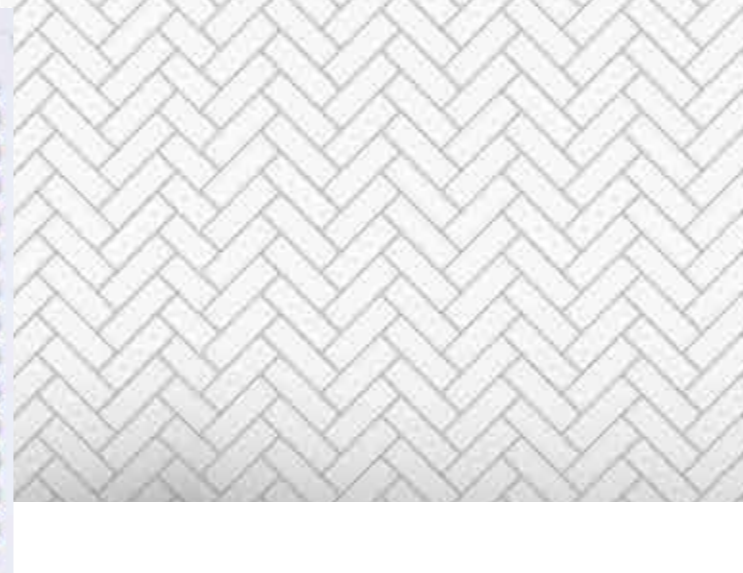

Sky Blue **G**



Vanilla White **G**



Fusion Collection (12x48 mm)

Fusion Collection (12x48 mm)

Lantern



Green

G

Fusion Collection (42X75 mm)

Octa-dot

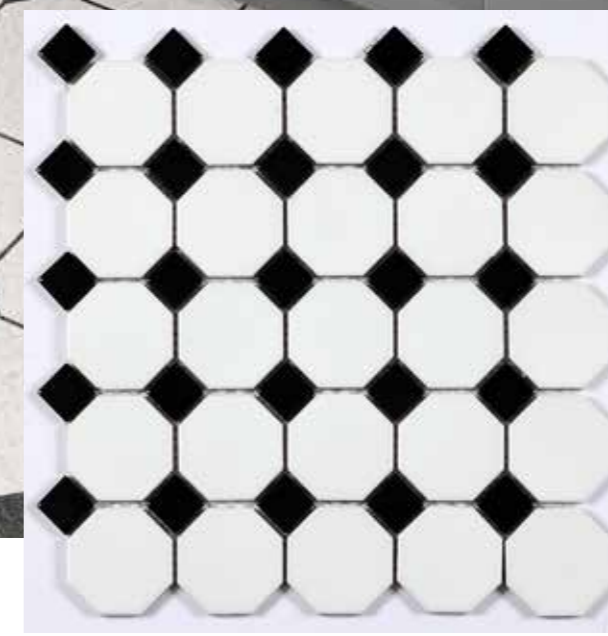

White & Black

M

Solid Collection (23X23/55X55 mm)

Elongated Honeycomb



Solid Collection *(48x117 mm)*

Lt. Grey

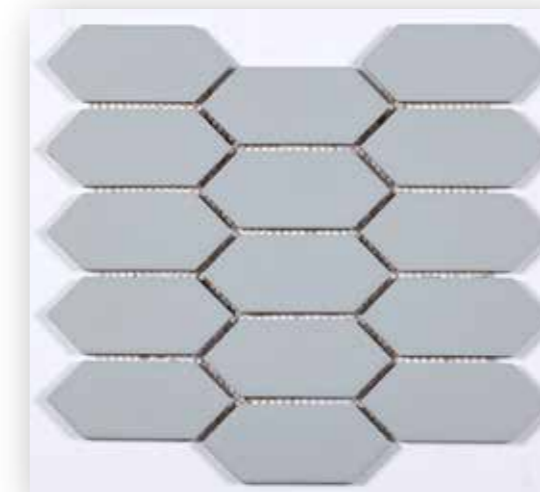

M

D. Grey



M

Other Application Areas

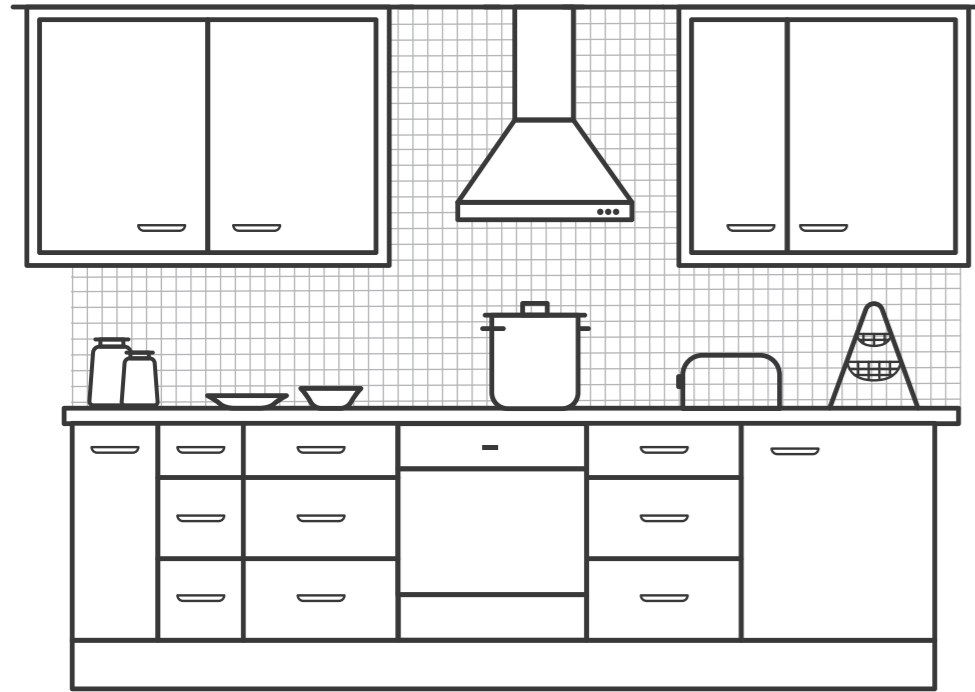

Kitchen

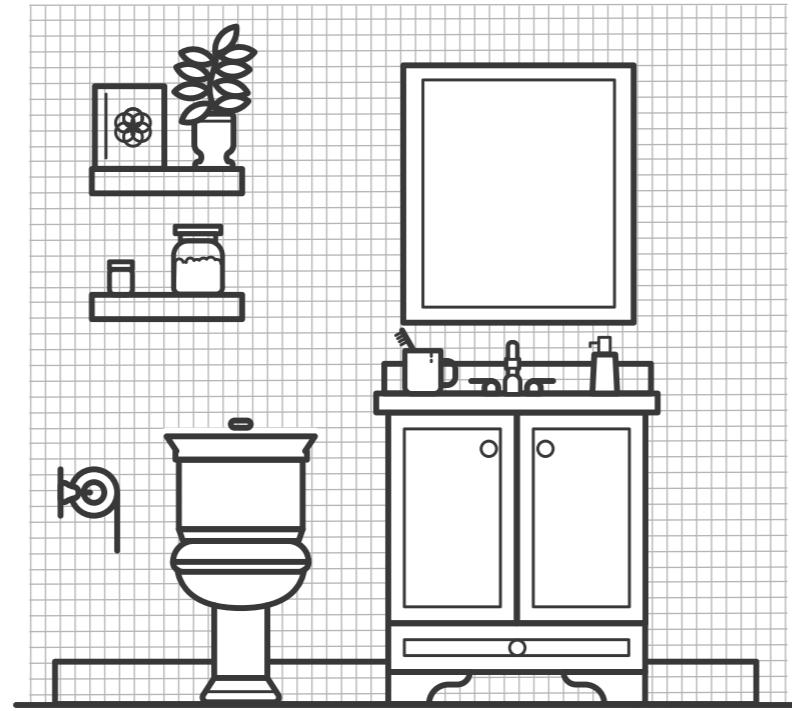

Bathroom

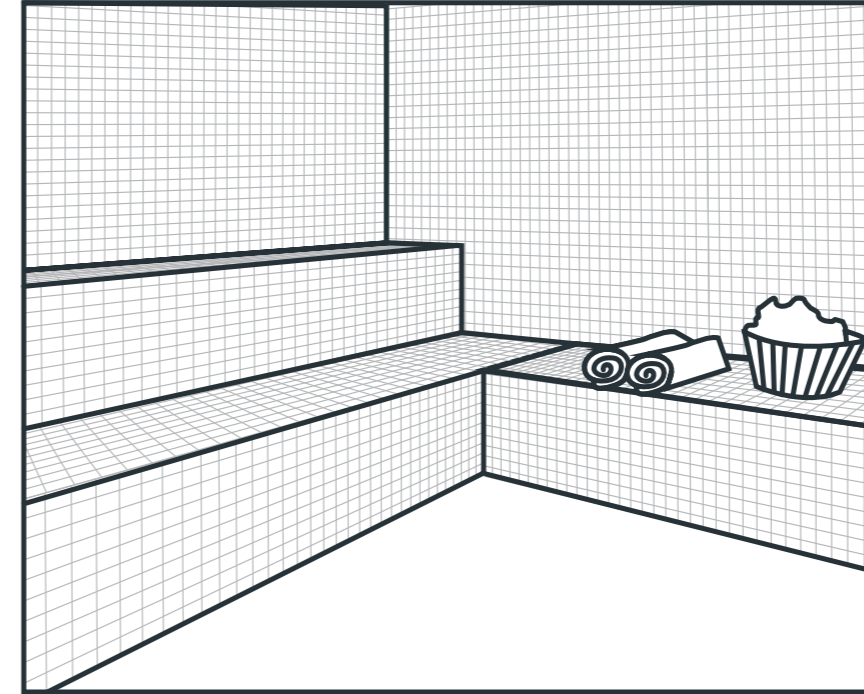

Steam & Sauna Room

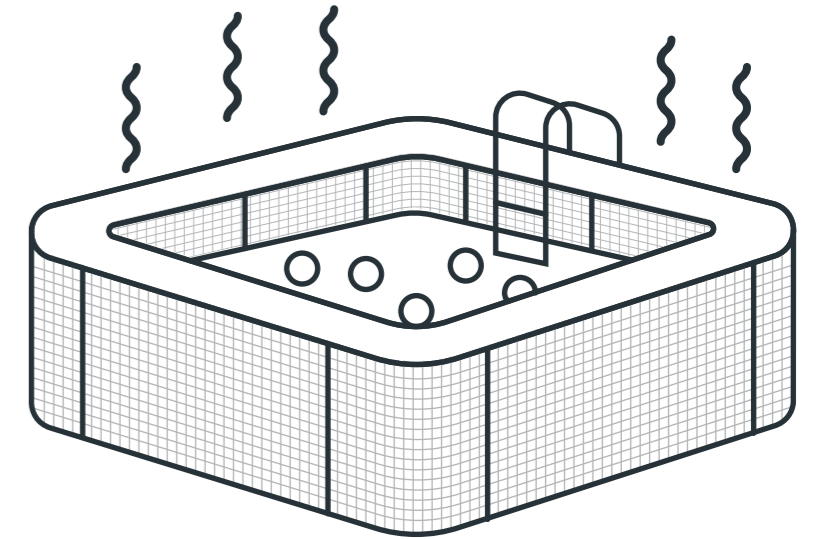

Jacuzzi

Other Application Areas

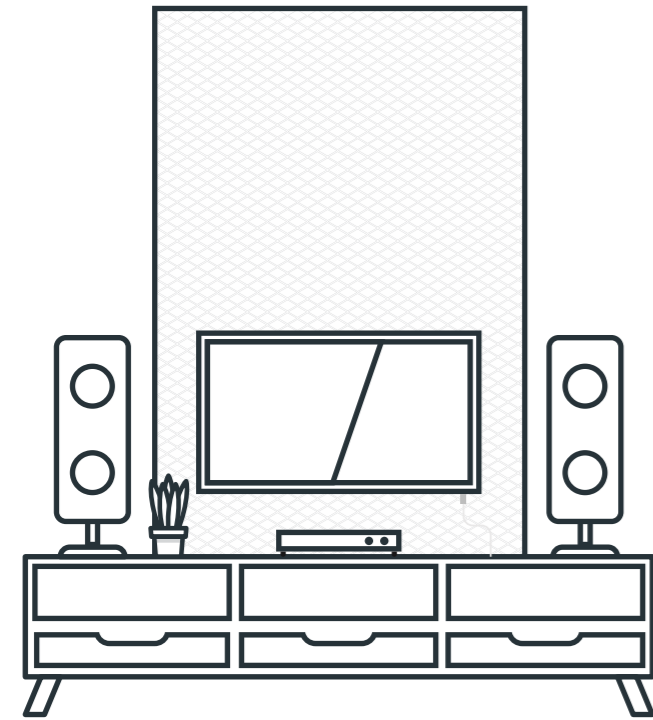

TV Unit Wall

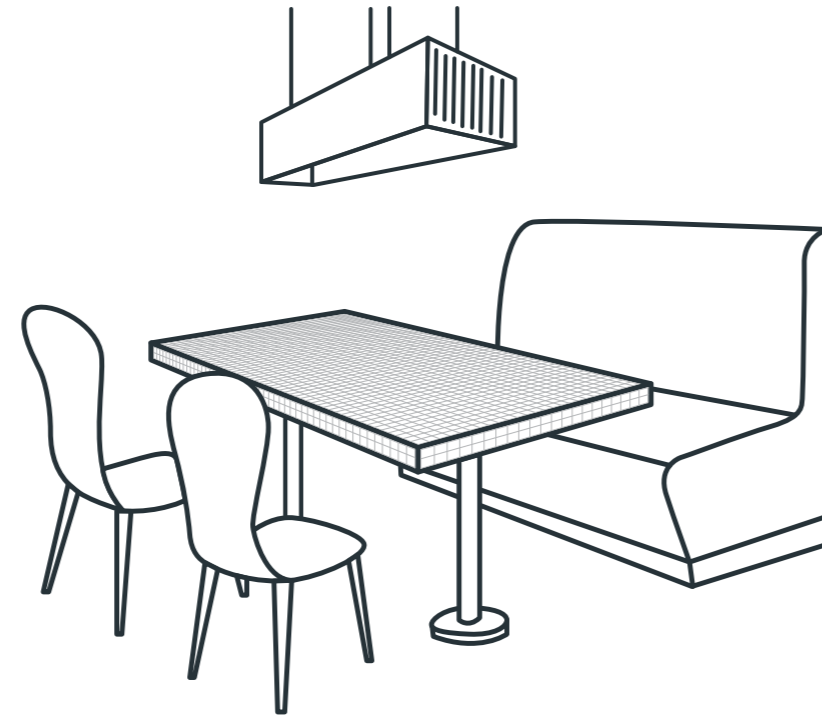

Restaurant Table

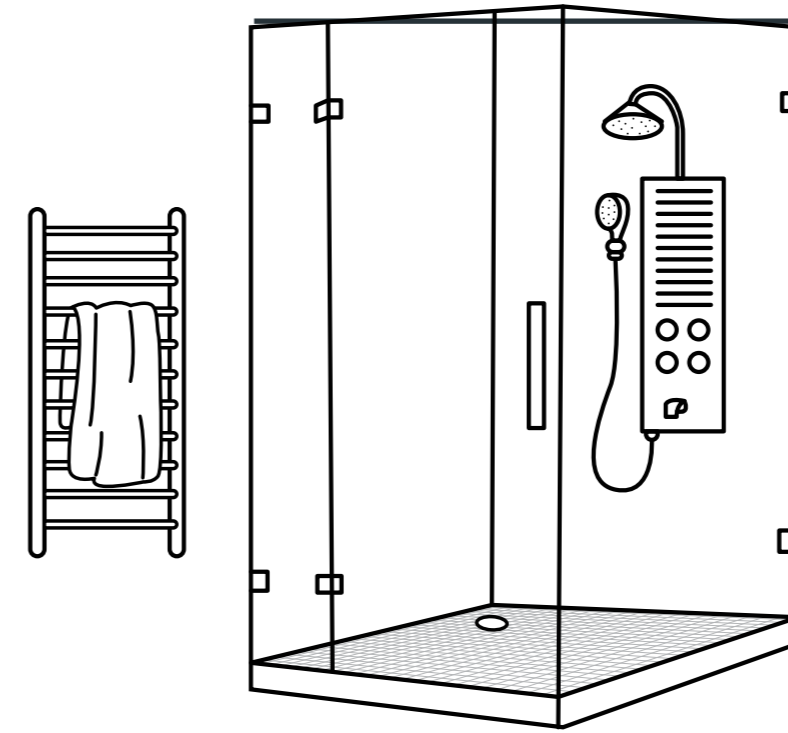

Bathroom Floor

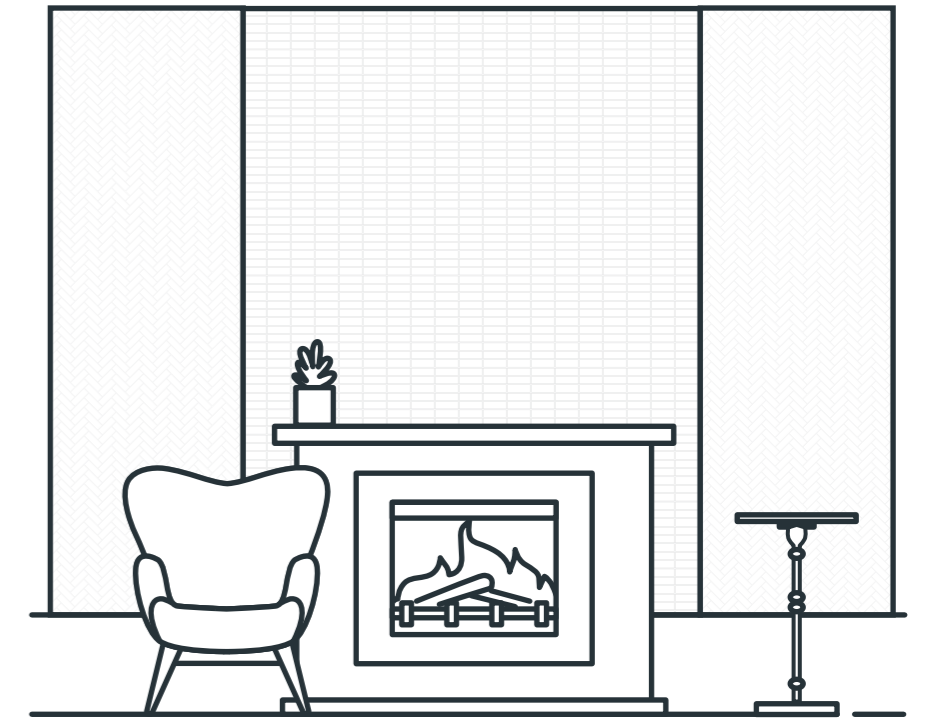

Fireplace Wall

Mosaic Installation Process

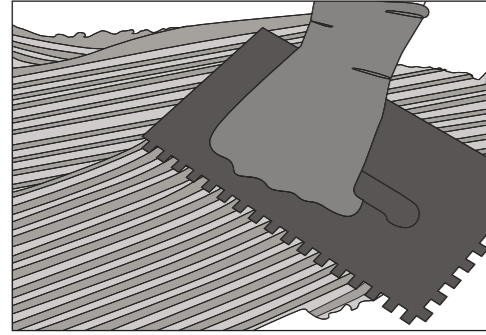

1. Skimming

- ◆ The installation surface must be smooth and clean to ensure proper installation.
- ◆ It may be necessary to lay a thin layer of setting material on the surface to ensure that it is ready for the tile.
- ◆ Allow 12 hours to dry if layer of setting material is needed.

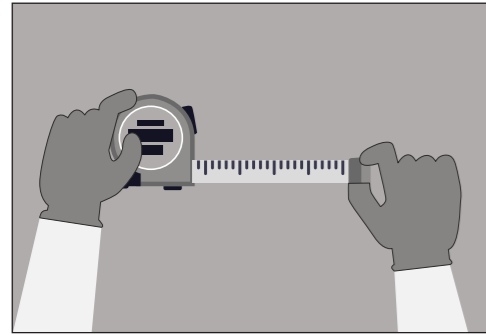

2. Guide Lines

- ◆ Measure the space in which the mosaic is being installed to determine the best fit for your tile.
- ◆ Use a straight edge and level to help you align the tile as you work.

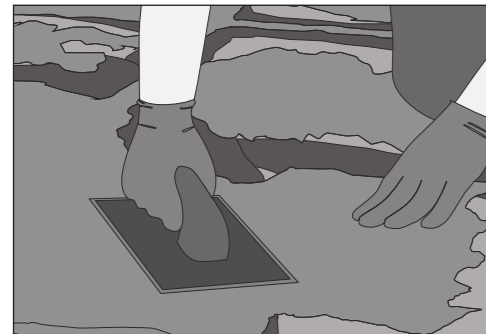

3. Applying Setting Material

- ◆ Mix setting material.
- ◆ First coat: apply setting material with the smooth edge of a trowel to a section no larger than one section of the grid.
- ◆ Second coat: create even ridges in the setting material by “combing” the material with the notched edge of the trowel.

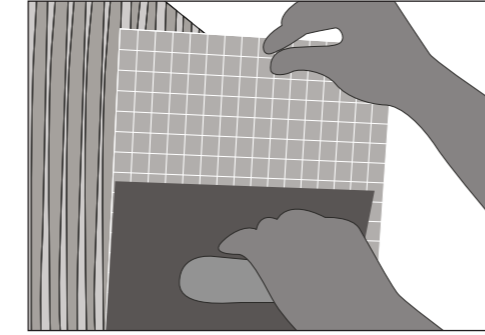

4. Installing the Tile

- ◆ Apply the backside of each sheet with the setting material.
- ◆ Using a float tool, tap across the surface to adhere the mosaic securely into the setting material.

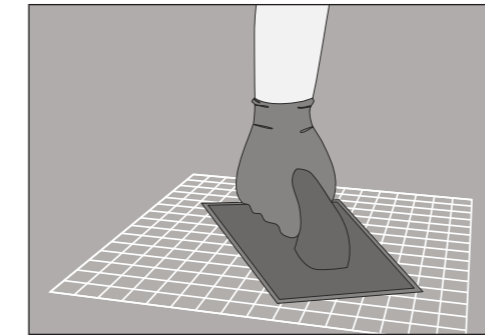

5. Securing Mosaic Sheets

- ◆ It is important to create a secure bond between the tiles and the setting material.
- ◆ Using the float tool tap across the surface to adhere the mosaic securely.
- ◆ This also ensures the final exposed plane of the mosaic is consistent and uniform in height.

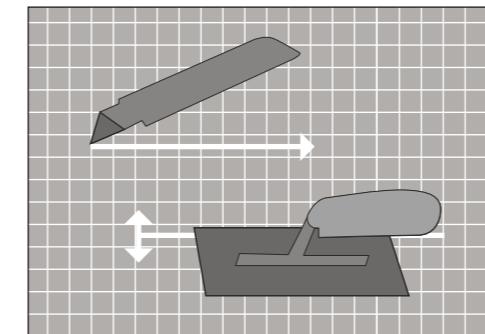

6. Adjusting Spacing

- ◆ This can be a time consuming process, but is important to ensure a professional installation.
- ◆ Adjust while material is still wet.
- ◆ Adjust any tiles that are uneven and ensure that all gaps are of equal width and height. Do this by cutting through the clear tape and moving tiles with a small trowel.

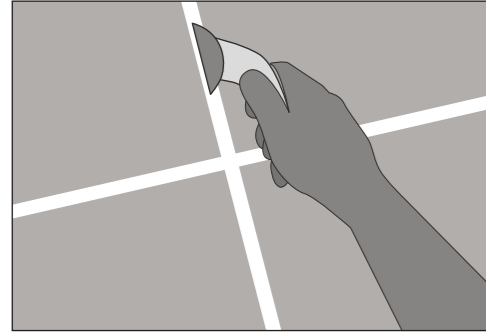

7. Grouting

- ◆ Grout can be applied to a clean, dry surface. (See Step 8 “Expansion Joints”)
- ◆ Before applying grout be sure that the mosaic surface is clean.
- ◆ Thorough cleaning may involve removing excess setting material from the mosaic’s joint with a knife, as well as cleaning off all dust and particles.
- ◆ Spread grout from the bottom up in a diagonal direction using a small trowel.
- ◆ Squeegee in the opposite direction.

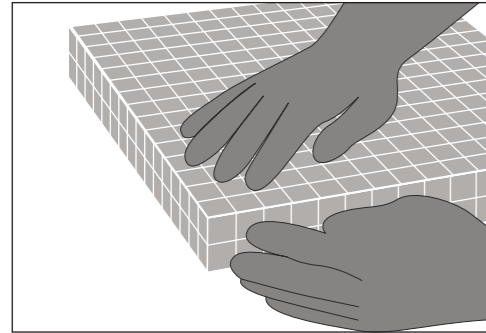

8. Expansion Joints

- ◆ Expansion joints should be installed at all “changes in plane” of the mosaic and where the mosaic meets an adjoining surface, such as in a corner.

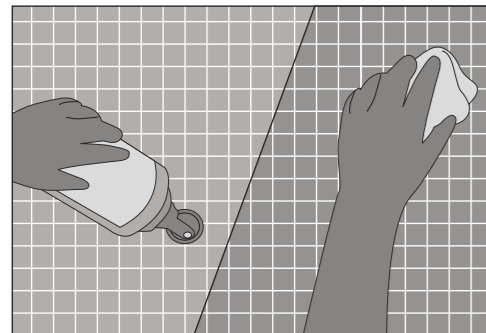

9. Cleaning & Sealing

- ◆ The mosaic should be ready to be cleaned about 30-60 minutes after grouting.
- ◆ Use a sponge and clean water and scrub in a circular motion, removing excess grout and smoothing all joints. Continue to wipe down the tiles until clean.
- ◆ Seal the grout after 72 hours of application.

NITCO

Technical Specifications Glazed Press Porcelain Mosaic (per pixel)

Sr.No.	Test Description	Euro Standard	NITCO's Value
1	Dimension & Surface Quality	+ 0.5%	+ 0.2%
2	Deviation in Thickness	± 0.6%	+ 0.2%
3	Straightness of sides	+ 0.3%	+ 0.2%
4	Rectangularity	+ 0.5%	+ 0.3%
5	Sace flatnessurf	Min.95%	Min.96%
6	Water Absorption	< 0.5 %	+ 0.35%
7	Bend Strength	> 150 Kg/cm	> 200-250 Kg/cm
8	Scratch Hardness (Moh’s)	Min.3%	Min.3%
10	Staining Resistance	Min.. Class 2	Class 5
11	Household Chemical	Min.. Class B	Household Chemical Except Hydro Fluoric Acid & its Derivatives
12	Thermal Shock	Resistant to 10 Cycle	Resistant
13	Thermal Expansion	Max. -9E ⁰⁶	<9 x 10 ⁶

The reproduction of tiles in this catalogue is restricted to four colour printing only and tiles are not relative in sizes. Conforming to ISO requirements, technical specifications of NITCO tiles are applicable only for first grade / first quality tiles. Please inspect all tiles prior to installation. Company will not entertain complaints once tiles are laid / fixed. Price category & PEI grade may change without any notice. Customers are advised to confirm it before placing order.

Finish

Glossy **G**

Area

Residential Area **A**

Application

Wall Tiles **W**

Floor Tiles **F**

Technical Characteristics

Chemical Resistance **C**

Fire Resistant **F**

Frost Resistant **F**

Stain Resistant **S**

Packing Details

S.No.	Pattern	Sheet Dimensions	Sheet / Box	Sq Mtrs	Sq Feet	Weight / Box (KG)
1	Square (Swimming Pool) 48x48mm	303x303mm	20	1.84	19.76	23.00
2	Honeycomb 51x59mm	277x322mm	20	1.78	19.20	22.05
3	Penny Circle 19mm	294x313mm	20	1.84	19.81	19.25
4	Penny Circle 30mm	320x330mm	20	2.11	22.73	24.00
5	Penny Circle 48mm	265x300mm	20	1.59	17.11	22.00
6	Herringbone 12x48mm	275x282mm	15	1.16	12.49	21.25
7	Brickbone 45x145mm	285x295mm	20	1.68	18.08	22.00
8	Brickbone 45x95mm	285x295mm	15	1.67	17.98	21.20
9	Lantern 42x75mm	260x265mm	20	1.38	14.85	16.75
10	Elongated Hexagon 48x117mm	258x288mm	20	1.48	15.93	19.00
11	Octa Dot 23x23/55x55mm	295x295mm	20	1.74	18.73	21.75
12	Honeycomb 23x25mm	255x295mm	20	1.50	16.19	18.00
13	Stackbone 12x93mm	285x295mm	15	1.26	13.56	20.00

NITCO

TILES MARBLE MOSAICO

NITCO LIMITED

Nitco House, Sheth Govindram Jolly Marg,
Kanjurmarg (E), Mumbai - 400042.
Tel.: +91-22-25772800 / 25772790.



NITCO Press Porcelain Mosaic Catalogue September 2023

www.nitco.in | 1800 266 4826

